

---

CATALOG

**Carlon®**

PVC conduit, elbows and fittings





---

**Thomas & Betts is now ABB Installation Products, but our long legacy of quality products and innovation remains the same. From connectors that wire buildings on Earth to cable ties that help put machines in space, we continue to work every day to make, market, design and sell products that provide a smarter, safer and more reliable flow of electricity, from source to socket.**

---

# Table of contents

<b>004</b>	<b>Carlton non-metallic push-in fittings</b>
<b>005</b>	<b>Carlton non-metallic expansion/deflection coupling</b>
<b>006</b>	<b>Carlton non-metallic strain-relief fittings</b>
<b>007–021</b>	<b>Electrical non-metallic tubing (ENT)</b>
<b>022–034</b>	<b>Flexible raceway systems</b>
<b>035–039</b>	<b>P&amp;C Flex conduit and fittings</b>
<b>040–041</b>	<b>Corrugated HDPE</b>
<b>042–057</b>	<b>Elbows, sweeps and accessories</b>
<b>058–067</b>	<b>Conduit bodies (for use with Schedule 40 and 80 conduit)</b>
<b>068–072</b>	<b>Switch and junction boxes</b>
<b>073–076</b>	<b>Straps, clamps and accessories</b>
<b>077–082</b>	<b>Spacers</b>
<b>083–088</b>	<b>Technical information</b>
<b>087–097</b>	<b>Index</b>

## Carlton® non-metallic push-in fittings

Superior pull-out performance and cost efficiency

**NEW**



### Features and benefits:

- Easy push-in installation in knockouts – no tools required
- Certified for one or two cables
- Insertion from inside or outside of enclosures increases installation flexibility
- Snug fit eliminates movement within knockout
- Exceeds pull-out requirements for better cable security
- Distinctive colors to differentiate sizes:  
1/2" gray, 3/4" blue
- UL® Listed, CSA Certified

01 Align the flat surface or opening with the burr of the knockout for easier insertion.

02 Insert the fitting into the knockout without the cables, from the inside or the outside of the enclosure.

03 For two-cable installation: both cables may be inserted at once or one after the other.

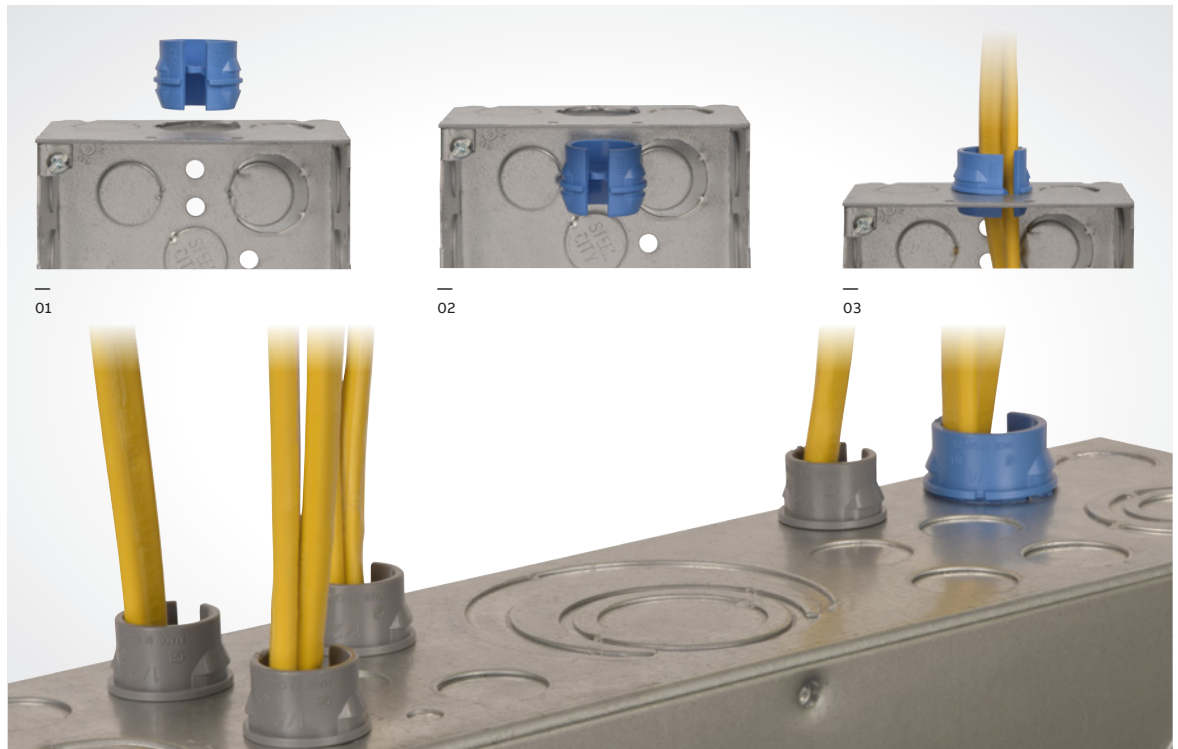

### Carlton non-metallic push-in fittings



Cat. No.	Description	Trade size (in.)	Clamping range		Suggested application (non metallic sheathed cable)	Packaging	
			Min. (in.)	Max. (in.)		Inner	Outer
SNM12-6R	Non-metallic fitting 1/2 in.	1/2	0.21	0.42	14/2 - 12/2 - 10/2 - 14/3 - 12/3 - 10/3 2 cables: 2 x 14/2 - 2 x 12/2 - 1 x 14/2 - 1 x 12/2	50	300
SNM12-100CP	Non-metallic fitting 1/2 in.	1/2	0.21	0.42	14/2 - 12/2 - 10/2 - 14/3 - 12/3 - 10/3 2 cables: 2 x 14/2 - 2 x 12/2 - 1 x 14/2 - 1 x 12/2	100	1000
SNM34-6R	Non-metallic fitting 3/4 in.	3/4	0.22	0.65	12/2 - 10/2 - 8/2 - 6/2 - 14/3 - 12/3 - 10/3 - 8/3 - 6/3 2 cables: 2 x 12/2 - 2 x 10/2 - 1 x 12/2 - 1 x 10/2	40	240
SNM34-100CP	Non-metallic fitting 3/4 in.	3/4	0.22	0.65	12/2 - 10/2 - 8/2 - 6/2 - 14/3 - 12/3 - 10/3 - 8/3 - 6/3 2 cables: 2 x 12/2 - 2 x 10/2 - 1 x 12/2 - 1 x 10/2	100	1000



## Carlton® non-metallic expansion/deflection coupling

Innovative design improves safety and saves labor time

**NEW**

Use the Carlton non-metallic expansion/deflection coupling to join two rigid PVC conduit runs in applications requiring movement in any direction at structural joints. It provides a flexible connection, safely accommodating axial or parallel deflection of up to 3/4" and angular deflection of up to 30° from relaxed position.

This coupling meets the requirements of 2014 National Electrical Code (NEC) Article 300.4(H) for use where a raceway crosses a structural joint intended for expansion, contraction or deflection in buildings, bridges, parking garages and similar structures.

### Features and benefits:

- Suitable for use indoors, outdoors, direct burial or embedded in concrete in bridges, piers, parking garages, overhead walkways, hospitals and other buildings
- Flexible neoprene outer jacket with tamperproof stainless steel straps ensures superior protection and corrosion resistance suitable for wet locations
- Inner sleeve provides a constant, smooth inner diameter in any position to ease wire pulling and prevent wire insulation damage
- Up to five times faster to install than the traditional method
- Up to 5-to-1 SKU reduction
- Can be used with Schedule 40 and Schedule 80 rigid PVC conduit
- UV resistant
- Patent pending

### Listings/compliances

- cULus Listed
- CSA certified to CSA C22.2 No. 85
- 2014 NEC Article 300.4(H) compliant

### Materials/finishes

- Coupling ends: smooth gray PVC
- Inner sleeve: smooth gray PVC
- Outer jacket: natural black molded neoprene
- Jacket straps: stainless steel

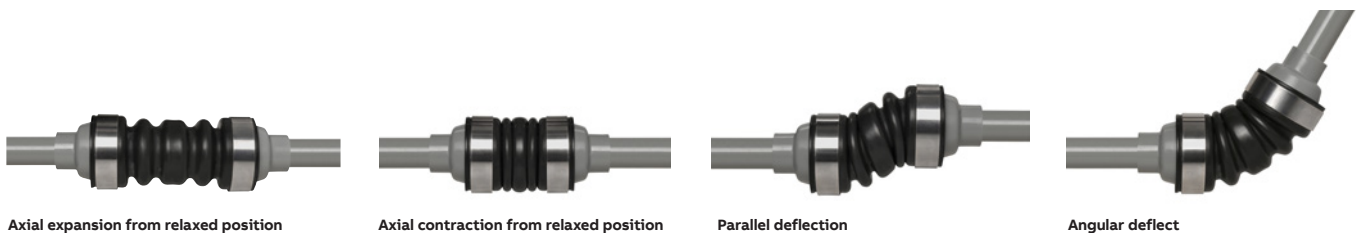

Carlton non-metallic expansion/deflection coupling



	Cat. No.	Trade size (in.)	Dimension A (in.)	Dimension B (in.)	UPC no.
	XD1NM	1/2	7.28	2.40	034481-02041
	XD2NM	3/4	7.36	2.66	034481-02043
	XD3NM	1	7.66	2.96	034481-02042
	XD5NM	1 1/2	8.26	3.60	034481-02044
	XD6NM	2	9.14	4.34	034481-02045
	XD7NM	2 1/2	10.75	5.15	034481-02046
	XD8NM	3	11.36	5.60	034481-02047
	XD10NM	4	12.25	7.17	034481-02048

\*Add 0.25" to O.D. clearance for strap buckle

## Carlton® non-metallic strain-relief fittings

NEW



### Features and benefits:

- For quick and reliable outdoor electrical installations
- 4 interchangeable elastomer bushings, accommodate a large range of NM-sheathed cables or cord cable size











Carlton non-metallic unthreaded strain relief fittings (to glue)



Cat. No.	Description	Trade size (in.)	NMD 90 cables (Loomex™-Romex™)	NMWU cables (in.)	Cord cables (in.)	Packaging
SRTC-050	½" Non-metallic threaded strain relief fitting.	½	14/3, 12/3, 10/3, 14/2, 12/2, 10/2	14/3, 14/2	0.240 - 0.450	Bag of 1.
SRC-075	¾" Non-metallic unthreaded strain relief fitting	¾	14/3, 12/3, 10/3, 8/3, 14/2, 12/2, 10/2	14/3, 12/3, 10/3, 14/2, 12/2	0.240 - 0.590	25 bags per outer 300
SRTC-075	¾" Non-metallic threaded strain relief fitting					









Carlton SRTC-050 fittings



Bushing	NMD 90 cables (Loomex™-Romex™)	NMWU cables	Cord cables diameter range (in.)
 	14/3	not applicable	0.240 to 0.340
 	12/3, 10/3	14/3	0.340 to 0.450
 	8/3	12/3	0.450 to 0.590
 	14/2, 12/2, 10/2	10/3	0.450 to 0.590
 		14/2	not applicable

Carlton SRTC-075 & SRC-075 fittings



Bushing	NMD 90 cables (Loomex™-Romex™)	NMWU cables	Cord cables diameter range (in.)
 	14/3	not applicable	0.240 to 0.340
 	12/3, 10/3	14/3	0.340 to 0.450
 	8/3	12/3, 10/3	0.450 to 0.590
 	14/2, 12/2, 10/2	14/2, 12/2	not applicable



# ENT

## Flex-Plus®



Flex-Plus ENT is a non-metallic flexible raceway for use in walls, floors and non-plenum ceilings. It's lightweight, hand-bendable and free from sharp edges, which reduces installation time and saves money.

### Options:

- Sizes ½" through 2"
- Colors can designate different voltages.  
Examples:
  - Yellow color for communication circuits and signaling cable
  - Red color for fire alarm circuits
  - Blue color for power circuits
- Packaging: coils or reels



### Standard stock – reels

Cat. No.	Size (in.)	Color	Nom. I.D. (in.)	Nom. O.D. (in.)	Pill tape	Min. bend radius (in.)	Reel size (F x W) (in.)	Reel type (W=wood)	Reel length	Reel wt. (lbs.)	Wt. per 100 Ft. (lbs.)
12005AK-001	½	Blue	.56	.84	Empty	6	36 x 24	W	1500	40	10
1205AKY-001	½	Yellow	.56	.84	Empty	6	36 x 24	W	1500	40	10
1205AKR-001	½	Red	.56	.84	Empty	6	36 x 24	W	1500	40	10
🍁 12005AKC-001	½	Blue	.56	.84	Empty	6	36 x 24	W	1500	40	10
12007AA-001	¾	Blue	.76	1.05	Empty	6	36 x 24	W	1000	40	14
1207AAY-001	¾	Yellow	.76	1.05	Empty	6	36 x 24	W	1000	40	14
1207AAR-001	¾	Red	.76	1.05	Empty	6	36 x 24	W	1000	40	14
🍁 1207AAC-001	¾	Blue	.76	1.05	Empty	6	36 x 24	W	1000	40	14
12008-750	1	Blue	1.00	1.315	Empty	6	36 x 24	W	750	40	20
12008Y-750	1	Yellow	1.00	1.315	Empty	6	36 x 24	W	750	40	20
12008R-750	1	Red	1.00	1.315	Empty	6	36 x 24	W	750	40	20
🍁 12008C-750	1	Blue	1.00	1.315	Empty	6	36 x 24	W	750	40	20
12009-750	1¼	Blue	1.402	1.66	Empty	7	48 x 32	W	750	90	19
12010-750	1½	Blue	1.554	1.90	Empty	8¼	48 x 32	W	750	90	39
12010Y-750	1½	Yellow	1.554	1.90	Empty	8¼	48 x 32	W	750	90	39
12011-500	2	Blue	2.030	2.375	Empty	9½	48 x 32	W	500	90	32
12011R-500	2	Red	2.030	2.375	Empty	9½	48 x 32	W	500	90	32
12011Y-500	2	Yellow	2.030	2.375	Empty	9½	48 x 32	W	500	90	32

\* 1¼"-2" available in yellow & red, made to order; consult factory.

🍁 Canada Only

## Flex-Plus ENT

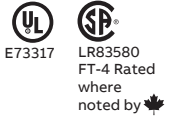

### Standard stock – coils

Cat. No.	Size (in.)	Color	Nom. I.D. (in.)	Nom. O.D. (in.)	Pill tape	Min. bend radius (in.)	Coil length (Ft.)	Wt. per 100 Ft. (lbs.)
12005-200	1/2	Blue	.56	.84	Empty	6	200	10
12005Y-200	1/2	Yellow	.56	.84	Empty	6	200	10
12005R-200	1/2	Red	.56	.84	Empty	6	200	10
12005C-370	1/2	Blue	.56	.84	Empty	6	200	10
12007-100	3/4	Blue	.76	1.05	Empty	6	100	14
12007Y-100	3/4	Yellow	.76	1.05	Empty	6	100	14
12007R-100	3/4	Red	.76	1.05	Empty	6	100	14
12007C-240	3/4	Blue	.76	1.05	Empty	6	100	14
12008-100	1	Blue	1.00	1.315	Empty	6	100	22
12008Y-100	1	Yellow	1.00	1.315	Empty	6	100	22
12008R-100	1	Red	1.00	1.315	Empty	6	100	22
12008C-160	1	Blue	1.00	1.315	Empty	6	100	22

Canada Only

### 10-ft. Lengths

Cat. No.	Size (in.)	Color	Nom. I.D. (in.)	Nom. O.D. (in.)	Std. Ctn.	Std. Wt. (lbs.)
12005-UPC	1/2	Blue	.56	.84	10 ft.	1.02
12007-UPC	3/4	Blue	.76	1.05	10 ft.	1.46
12008-010	1	Blue	1.00	1.315	10 ft.	2.96

**Note:** The solid blue color of ENT conduit is a registered trademark of Carlon. ENT may show color deterioration in direct sunlight when stored outdoors over an extended period of time. It is suggested that all ENT products not be stored outside. Section 362.12(8) of the NEC<sup>®</sup> prohibits ENT to be used in areas exposed to direct sunlight.

NEC and National Electrical Code are registered trademarks of the National Fire Protection Association, Inc.



## Stub downs

Carlson vertical stub downs are designed to provide a quick, easy connection to a wood deck or transition from slab-to-slab using Carlson's "Quick Connect" snap-in design... simply snap the ENT in place. The integral snaps provide a secure mount – preventing the ENT from pulling out while enabling easy removal of the fitting once the deck is removed. All in a concrete-tight application. The underside of this fitting provides ample room to attach a Carlson coupling to the ENT to continue the run. Carlson vertical stub downs are manufactured out of a highly engineered thermoplastic material to provide extra strength and durability and are available in sizes ½", ¾" and 1".

Carlson 45° Stub downs are designed to provide a smooth transition from cross-deck ENT runs to vertical applications. The integral snaps provide a secure mount – preventing the ENT from slipping or pulling out – but also enable the stub to easily be removed. The underside of this fitting provides ample room to attach a Carlson coupling to the ENT to continue the run. Carlson 45° Stub downs are manufactured out of a highly engineered thermoplastic material to provide extra strength and durability. They're concrete tight and available in sizes ½", ¾" and 1".

### Vertical stub down



Cat. No.	Size	Std. Ctn.	Std. Wt. (lbs.)
A210D	½"	50	3.8
A210E	¾"	50	3.7
A210F	1"	50	4.8

### 45° stub down

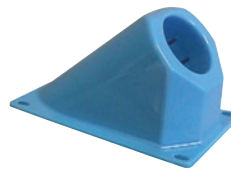

Cat. No.	Size	Std. Ctn.	Std. Wt. (lbs.)
A220D	½"	25	1.8
A220E	¾"	25	2.0
A220F	1"	25	2.6
A220G	1¼"	25	2.8
A220H	1½"	25	3.3
A220J	2"	25	4.1

Carlson non-metallic exclusive... Carlson vertical stub down transition adapters, like our vertical stub downs, provide a means to transition from ENT to another wire-management product where code requires other wire-management means. The integral snaps provide a secure mount – preventing the ENT from slipping or pulling out, while the deck-mount flange has a threaded port, enabling connection to other conduit system using a terminal adapter. Carlson vertical stub down transition adapters are manufactured out of polycarbonate material to provide extra strength and durability. They're concrete tight and available in sizes ½", ¾" and 1".

Carlson non-metallic exclusive... Carlson 90° Stub Downs are designed to provide a smooth transition from cross-deck ENT runs to vertical applications where code requires other wire-management means. The integral snaps provide a secure mount – preventing the ENT from slipping or pulling out, while the deck-mount flange has a threaded port, enabling connection to any conduit system using a terminal adapter. Carlson 90° Stub Downs are manufactured out of polycarbonate material to provide extra strength and durability. They're concrete tight and available in sizes ½", ¾" and 1".

### Vertical stub down transition adapter



Cat. No.	Size	Std. Ctn.	Std. Wt. (lbs.)
A200D	½" Female ENT to NPSC (Female)	50	2.3
A200E	¾" Female ENT to NPSC (Female)	50	2.8
A200F	1" Female ENT to NPSC (Female)	50	3.9

### 90° stub down transition adapter



Cat. No.	Size	Std. Ctn.	Std. Wt. (lbs.)
A230D	½" Female ENT to NPSC (Female)	25	2.0
A230E	¾" Female ENT to NPSC (Female)	25	2.4
A230F	1" Female ENT to NPSC (Female)	25	3.3

## Mud box assemblies

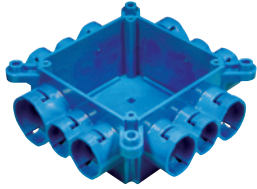

Mud box base with blank cover

Carlson mud box assemblies are available in five unique styles...blank, ceiling ring, one-gang, two-gang and 4-inch square. All mud box assemblies are manufactured out of polycarbonate material to provide extra strength and durability, are concrete tight and have twelve integral connectors...two 1", six 3/4" and four 1/2". Using our new ENT Reducers, this product will meet ANY jobsite application.



Cat. No.	Size	Std. Ctn.	Std. Wt. (lbs.)
A863BC	Mud Box with Blank Cover	24	12.3

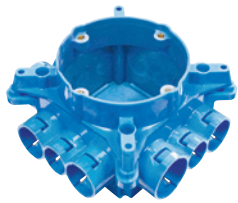

Mud box base with ceiling ring

**Features and benefits:**

- Threaded brass inserts for fan (#10-32 screws) and fixture (#8-32 screws) mountings
- Listed for fixture support up to 50 lbs.
- Listed for ceiling fans up to 35 lbs.



Cat. No.	Size	Std. Ctn.	Std. Wt. (lbs.)
A863CF	Mud Box with Blank Cover	24	15.5
▶ A863CFG	Mud Box with Ceiling Ring & Ground Lug	24	16.1

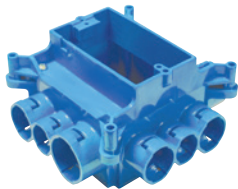

Mud box with one-gang ring



Cat. No.	Size	Std. Ctn.	Std. Wt. (lbs.)
A863S	Mud Box with One-Gang Ring	24	16.8
▶ A863SG	Mud Box with One-Gang Ring & Ground Lug	24	16.2



## Mud box assemblies

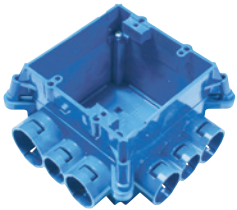

Mud box with two-gang ring



Cat. No.	Size	Std. Ctn.	Std. Wt. (lbs.)
A863D	Mud box with two-gang ring	24	15.8
▶ A863DG	Mud box with two-gang ring & ground lug	24	16.6

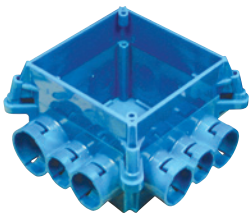

Mud box with 4" square ring



Cat. No.	Size	Std. Ctn.	Std. Wt. (lbs.)
A863-4SQ	Mud box with 4-inch square ring	24	15.2

### Features and benefits:

- Threaded brass inserts for fan (#10-32 screws) and fixture (#8-32 screws) mountings
- Listed for fixture support up to 50 lbs.
- Listed for ceiling fans up to 35 lbs.



Mud box with one-gang ring



Cat. No.	Size	Std. Ctn.	Std. Wt. (lbs.)
A863-4SQF	4-Square ring	24	17.15
A863CFF	Ceiling ring	24	16.61
A863CFGF	Ceiling ring and ground lug	24	17.46
A863DF	Double-gang	24	17.42
A863DGF	Double-gang and ground lug	24	17.99
A863SF	Single-gang	24	17.15
A863SGF	Single-gang and ground lug	24	17.44

Carlson Mud Box Assemblies with mounting feet are specifically engineered and designed for use in Tunnel Form applications. The mounting feet are located on all four corners and enable the box to attach directly to the wall of the form using pop rivets. The pop rivets help keep the box in position during the pour and provide a safe, secure and rust-resistant mount.

## Mounting brackets

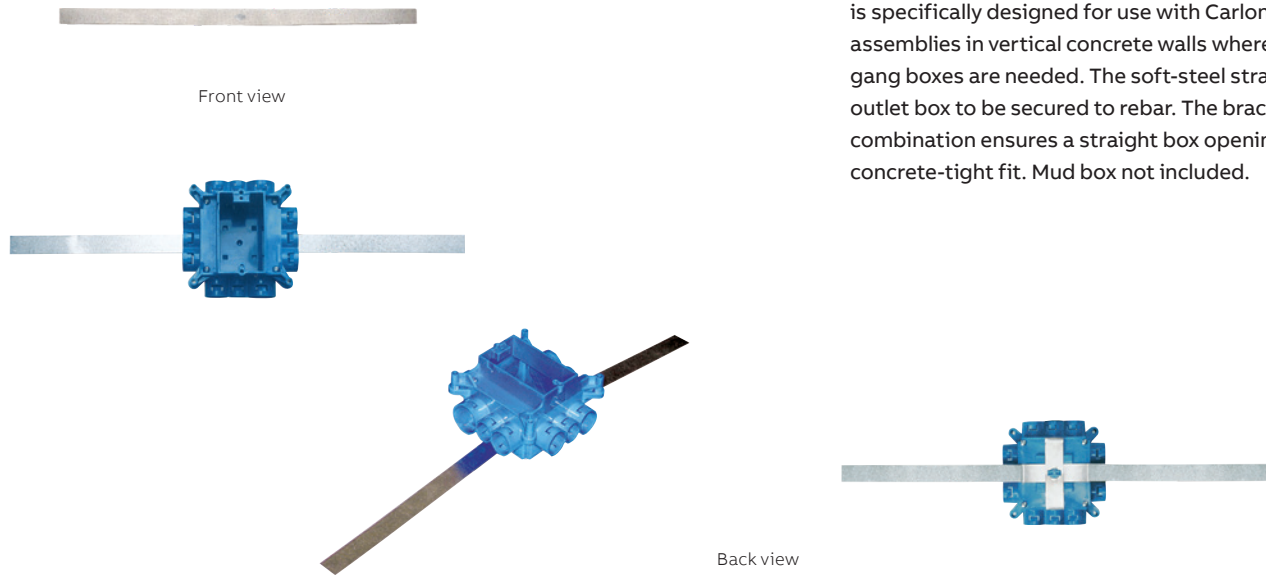

CARLON EXCLUSIVE...The Carlon ENT mounting bracket is specifically designed for use with Carlon ENT mud box assemblies in vertical concrete walls where one- or two-gang boxes are needed. The soft-steel strap enables the outlet box to be secured to rebar. The bracket combination ensures a straight box opening and a concrete-tight fit. Mud box not included.

Mud box base with blank cover

Cat. No.	Size	Std. Ctn.	Std. Wt. (lbs.)
A863MB	Mud box mounting kit	1	.98

## ENT Bridge

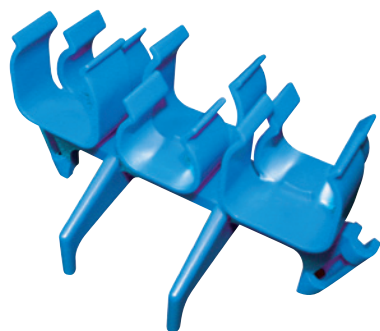

CARLON EXCLUSIVE...The Carlon ENT Bridge is designed to support long ENT runs in concrete pour applications. This makes pulling wire/cable a snap. Installation is easy...simply mount the ENT bridge, using nails or screws, to the wood deck mounting and snap the ENT into place. The bridge is designed to hold the conduit in place while minimizing dips in the conduit over long runs. The Carlon ENT Bridge is manufactured out of a highly engineered thermoplastic material to provide extra strength and durability and can accommodate ENT sizes 1/2", 3/4" and 1". (The Carlon ENT bridge can be used with rigid non-metallic conduit too.)

Mud box base with blank cover

Cat. No.	Size	Std. Ctn.	Std. Wt. (lbs.)
A293DEF	ENT Bridge	50	9.0

## Transition adapters



Male ENT to Schedule 40 and 80 PVC conduit



Cat. No.	Size	Std. Ctn.	Std. Wt. (lbs.)
A263D	1/2" ENT to 1/2" Sch. 40 or Sch. 80	100	2.4
A263E	3/4" ENT to 3/4" Sch. 40 or Sch. 80	100	3.2
A263F	1" ENT to 1" Sch. 40 or Sch. 80	100	4.5

CARLON EXCLUSIVE...Carlson male ENT to Schedule 40 & 80 PVC conduit transition adapters are designed to connect Schedule 40 conduit to Carlson Flex-Plus Blue ENT boxes and fittings. Simply solvent cement the PVC adapter to the Schedule 40 conduit and snap the adapter into Carlson's "Quick Connect" snap-in connector on the box or fitting. Carlson Male ENT to Schedule 40 & 80 adapters are concrete tight and available in sizes 1/2", 3/4" and 1".



ENT to EMT



Cat. No.	Size	Std. Ctn.	Std. Wt. (lbs.)
A245D	1/2" ENT to 1/2" EMT	100	3.4
A245E	3/4" ENT to 3/4" EMT	100	4.1
A245F	1" ENT to 1" EMT	100	5.4

Carlson ENT to EMT transition adapters are designed to easily transition from Carlson Flex-Plus Blue ENT to EMT using Carlson's "Quick Connect" snap-in design. The EMT is held securely in place using the small screw (provided). This helps prevent the EMT from slipping/shifting out of the adapter. All ENT to EMT adapters are manufactured out of polycarbonate material to provide extra strength and durability. They're concrete tight and available in sizes 1/2", 3/4" and 1".



ENT to EMT



Cat. No.	Size	Std. Ctn.	Std. Wt. (lbs.)
A273DE	3/4"-1/2"	100	3.2
A273EF	1"-3/4"	100	2.4

CARLON EXCLUSIVE...Carlson ENT reducers are designed to provide an easy transition from 1" Carlson ENT to 3/4" ENT or from 3/4" Carlson ENT to 1/2" ENT. They're concrete tight and manufactured out of polycarbonate material to provide extra strength and durability. Carlson ENT reducers provide flexibility while on the jobsite by minimizing the need to carry size-specific boxes and fittings. Carlson ENT reducers provide the versatility to convert Carlson fittings and boxes to many different sizes and configurations.

## Outlet and switch boxes

### Eccentric knockouts

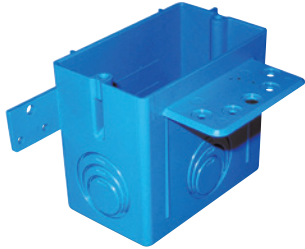

A122

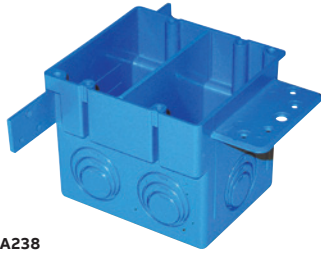

A238

CARLON EXCLUSIVE...Carlson ENT outlet and switch boxes with eccentric knockouts are designed to enable selective ENT openings – ½", ¾" and 1" – based on application needs. They provide the largest capacity available on the market today – 22 cu. in. Single-gang, and 38 cu. in. Double-gang – and can be mounted to wood or steel studs. Carlson ENT outlet and switch boxes with eccentric knockouts are manufactured out of a highly engineered thermoplastic material to provide extra strength and durability and are available in single-gang and double-gang styles.

**Note:** The double-gang version is also a 4-in. square box.

—  
Single-gang — 22 cu. in.



Cat. No.	Size	Capacity (cu. in.)	Std. Ctn.	Std. Wt. (lbs.)
A122	Single-gang	22	25	6.8

—  
Single-gang — 38 cu. in.

Cat. No.	Size	Capacity (cu. in.)	Std. Ctn.	Std. Wt. (lbs.)
A238	Two-gang	38	25	8.9

## Outlet box

### Divider

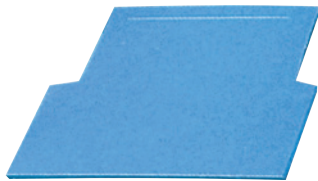

Carlson ENT outlet box divider is specifically designed for applications where a combined high- and low-voltage closed-back box is needed, such as for placement in a fire-rated wall. Just slip the divider into place to get the split box you need. The Carlson ENT outlet box divider is UL® Recognized for use with the Carlson A238 box only.

—  
Outlet box divider



Cat. No.	Size	Std. Ctn.	Std. Wt. (lbs.)
A238DIV	—	50	1.87



## Quick-Connect

### Adapters and couplings



Coupling



Threaded adapter



Snap-in adapter

#### Features and benefits:

- Carlon one-piece ENT Quick-Connect couplings, threaded adapters and snap-in terminator adapters are suitable for damp locations
- Quick-Connect couplings and threaded adapters are concrete-tight when used with Carlon ENT
- All sizes of rigid non-metallic conduit fittings are compatible with ENT when using ENT cement
- Rigid non-metallic conduit fittings are recommended for use with Carlon 1<sup>1</sup>/<sub>4</sub>"–2" Flex-Plus Blue ENT
- Use of ENT Blue Quick-set cement is required. See page 53 for details
- When one-piece Quick-Connect snap-in terminator adapters are installed in a concrete application, Carlon flat sealing washers must be used on the box connection ends

#### Couplings

Cat. No.	Size (in.)	Std. Ctn.	Std. Wt. (lbs.)
A240D	1/2	150	2.90
A240E	3/4	100	3.00
A240F	1	50	2.30

#### Threaded adapters

Cat. No.	Size (in.)	Std. Ctn.	Std. Wt. (lbs.)
A243D	1/2	150	2.55
A243E	3/4	100	2.30
A243F	1	50	2.00

#### Snap-in adapters



Cat. No.	Size (in.)	Std. Ctn.	Std. Wt. (lbs.)
A253D	1/2	150	2.70
A253E	3/4	100	2.90
A253F	1	50	2.30

## Rigid non-metallic

### Conduit adapters and couplings



For adapting non-metallic conduits to boxes, threaded fittings, metallic systems. Male threads on one end, socket end on other.

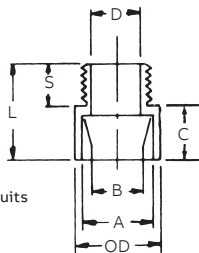

#### Male terminal adapters

Cat. No.	Size	Std. Ctn.	Typical		Min. D	Max. OD	C	S	L	Std. Wt. (lbs.)
			A	B						
E943D	1/2	150	.852	.836	.597	1 <sup>1</sup> / <sub>8</sub>	5/16	9/16	1 <sup>3</sup> / <sub>16</sub>	2.8
E943E	3/4	125	1.064	1.046	.800	1 <sup>1</sup> / <sub>2</sub>	3/4	9/16	1 <sup>3</sup> / <sub>8</sub>	3.5
E943F	1	50	1.330	1.310	1.018	1 <sup>5</sup> / <sub>8</sub>	1	1 <sup>1</sup> / <sub>16</sub>	1 <sup>29</sup> / <sub>32</sub>	3
E943G	1 <sup>1</sup> / <sub>4</sub>	50	1.677	1.655	1.332	2 <sup>1</sup> / <sub>32</sub>	1	3/4	1 <sup>5</sup> / <sub>16</sub>	4
E943H	1 <sup>1</sup> / <sub>2</sub>	25	1.918	1.894	1.566	2 <sup>9</sup> / <sub>32</sub>	1 <sup>3</sup> / <sub>16</sub>	3/4	2 <sup>1</sup> / <sub>16</sub>	2.5
E943J	2	50	2.393	2.369	2.000	2 <sup>2</sup> / <sub>32</sub>	1 <sup>3</sup> / <sub>16</sub>	3/4	2 <sup>1</sup> / <sub>2</sub>	7

\*All measurements in inches, unless otherwise noted.

All socket fittings should be attached using ENT Blue Quick-Set Cement (page 53). Using Carlon fittings with Carlon non-metallic conduit ensures system integrity.



Socket type for joining non-metallic conduit.

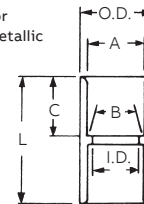

#### Standard couplings

Cat. No.	Size	Std. Ctn.	Typical		Max. OD	C	L	Std. Wt. (lbs.)	
			A	B					
E940D	1/2	150	.852	.836	.728	1 <sup>1</sup> / <sub>8</sub>	1 <sup>1</sup> / <sub>16</sub>	1 <sup>1</sup> / <sub>2</sub>	2.8
E940E	3/4	100	1.064	1.046	.840	1 <sup>5</sup> / <sub>8</sub>	3/4	1 <sup>5</sup> / <sub>8</sub>	3.5
E940F	1	50	1.330	1.310	1.210	1 <sup>5</sup> / <sub>8</sub>	1 <sup>5</sup> / <sub>16</sub>	2	3
E940G	1 <sup>1</sup> / <sub>4</sub>	30	1.677	1.655	1.535	1 <sup>63</sup> / <sub>64</sub>	1	2 <sup>1</sup> / <sub>8</sub>	4
E940H	1 <sup>1</sup> / <sub>2</sub>	25	1.918	1.894	1.755	2 <sup>13</sup> / <sub>64</sub>	1 <sup>1</sup> / <sub>8</sub>	2 <sup>3</sup> / <sub>8</sub>	2.5
E940J	2	30	2.393	2.369	2.190	2 <sup>47</sup> / <sub>64</sub>	1 <sup>3</sup> / <sub>16</sub>	2 <sup>1</sup> / <sub>2</sub>	7

\*All measurements in inches, unless otherwise noted.

## 2<sup>1</sup>/<sub>2</sub>" and 4"

### Mud boxes and covers

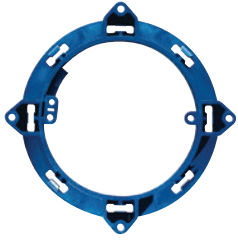

Base rings

#### Features and benefits:

- UL Classified for 2-hour-or-less fire-resistant floor/ceiling assemblies
- Listed for use with ceiling fans up to 35 lbs and for fixture support up to 50 lbs.



Cat. No.	Size	Std. Ctn.	Std. Wt. (lbs.)
A861	Without ground lug	10	2.5
C861G	With ground lug	10	2.0



Covers

Cat. No.	Size	Std. Ctn.	Std. Wt. (lbs.)
A862D	2 <sup>1</sup> / <sub>2</sub> Deep (1/2" KOs)	10	2.5
A862E	2 <sup>1</sup> / <sub>2</sub> Deep (3/4" KOs)	10	2.1
A864D	4 Deep (1/2" KOs)	10	2.9
A864E	4 Deep (3/4" KOs)	10	2.9
A864F	4 Deep (1" KOs)	10	3.0

## Quick-Connect

### Outlet and switch boxes



Single-gang – 16 cu. in.

#### Features and benefits:

- Suitable for masonry walls
- Meets NEMA OS-2
- UL Classified for 2-hour-or-less fire-resistant wall assemblies



E11461

Cat. No.	Size	Std. Ctn.	Std. Wt. (lbs.)
A58381D	3 x 2 <sup>1</sup> / <sub>4</sub> x 3 (1/2" KOs)	25	4.6
A58381E	3 x 2 <sup>1</sup> / <sub>4</sub> x 3 (3/4" KOs)	25	4.6



4" Square – 20 cu. in.

Cat. No.	Size	Std. Ctn.	Std. Wt. (lbs.)
A52151D	4 x 4 x 1 <sup>1</sup> / <sub>2</sub> (1/2" KOs)	100	22.6
A52151E	4 x 4 x 1 <sup>1</sup> / <sub>2</sub> (3/4" KOs)	100	22.6
A521DE	4 x 4 x 1 <sup>1</sup> / <sub>2</sub> (1/2" & 3/4" KOs)	100	22.6

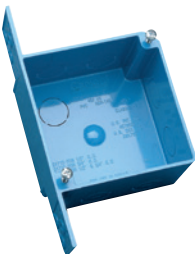

4" Square – 30.3 cu. in.

Cat. No.	Size	Std. Ctn.	Std. Wt. (lbs.)
A52171D	4 x 4 x 2 <sup>3</sup> / <sub>8</sub> (1/2" KOs)	25	7.6
A52171E	4 x 4 x 2 <sup>3</sup> / <sub>8</sub> (3/4" KOs)	25	7.6
A5217DE	4 x 4 x 2 <sup>3</sup> / <sub>8</sub> (1/2" & 3/4" KOs)	25	7.6

## ENT Box

With adapters

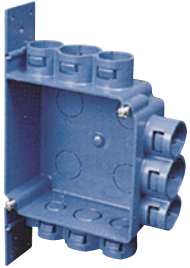

4" Square – 24.75 cu. in. ENT box with adapters



Cat. No.	Size	Std. Ctn.	Std. Wt. (lbs.)
A5329DE	4 x 4 x 1 <sup>3</sup> / <sub>4</sub> (1/2" & 3/4" KOs)	50	14.8



Box back wall support

Cat. No.	Size	Std. Ctn.	Std. Wt. (lbs.)
A540DS	For use with 1/2" knockout	100	2.1

## ENT Box

Extenders



Features and benefits:

- UL Classified for 2-hour-or-less fire-resistant wall assemblies

Single-gang



Cat. No.	Rise (in.)	Cu. In.	Std. Ctn.	Std. Wt. (lbs.)
A410	1/2	3.5	100	7.7
A411	5/8	4.2	50	4.6
A412	3/4	5.0	50	5.1
A413	1	6.6	40	5
A414	1 1/4	8.1	30	4.4

Two-gang

Cat. No.	Rise (in.)	Cu. In.	Std. Ctn.	Std. Wt. (lbs.)
A400	Blank	—	—	7.7
A420	1/2	6.1	6.1	5.0
A421	5/8	7.4	7.4	4.2
A422	3/4	8.8	8.8	4.8



## Round covers

For octagon ceiling boxes



### Features and benefits:

- Listed for fixture support up to 50 lbs.
- UL Classified for 2-hour-or-less fire-resistant assemblies

### Round plaster rings



Cat. No.	Rise (in.)	Cu. In.	Std. Ctn.	Std. Wt. (lbs.)
A471	1/2	3.2	100	3.3
A472	3/4	4.0	100	3.7



### Round blank covers

Cat. No.	Rise (in.)	Cu. In.	Std. Ctn.	Std. Wt. (lbs.)
E460R-CAR	Blank	-	35	2.2
A470D	Blank with 1/2" KO	-	100	4.7

## Quick Connect 4"

### Octagon ceiling boxes



Ceiling box – 20.5 cu. in.



E11461

Cat. No.	Size	Std. Ctn.	Std. Wt. (lbs.)
A615D	(4) 2 1/8" Deep (1/2" KOs)	50	6.4
A615E	(4) 2 1/8" Deep (3/4" KOs)	50	6.4
A615DE	(4) 2 1/8" Deep (1/2" & 3/4" KOs)	50	6.4



Ceiling box with J mount – 20.5 cu. in.



E11461

Cat. No.	Size	Std. Ctn.	Std. Wt. (lbs.)
A615DJ	(4) 2 1/8" Deep (1/2" KOs)	50	18.7



Ceiling box with L bracket – 20.5 cu. in.



E11461

Cat. No.	Size	Std. Ctn.	Std. Wt. (lbs.)
A615DL	(4) 2 1/8" Deep (1/2" KOs)	50	6.4



Ceiling box with adjustable hanger bar – 20.5 cu. in.



E11461

Cat. No.	Size	Std. Ctn.	Std. Wt. (lbs.)
A615DH	(4) 2 1/8" Deep (1/2" KOs)	25	13.6

## PVC Conduit cutters



For fast, smooth field cuts of ½" through 1" Flex-Plus Blue ENT.

Cat. No.	Size (in.)	Std. Ctn.
CC120B	8	10

## Tape

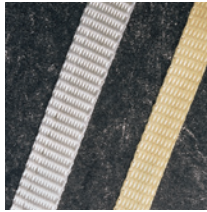

Prelubricated, woven polyester tape made from low-friction, high abrasion-resistant yarns, providing a low coefficient of friction. Tape is printed with sequential footage markings for accurate measurements.

Cat. No.	Size (in.)	Tensile strength (lbs.)	Teel lengths (ft.)
TL14505	½	1250	5000
TL14510	½	1250	10000
TL38203	⅝	1800	3000
TL38265	⅝	1800	6500
TL38210	⅝	1800	10000

Other tapes are available. Consult your sales service location for additional information.

## Carlon Low VOC cement

(MSDS sheets available at [www.carlon.com](http://www.carlon.com))



ENT cement required for use with ENT and rigid non-metallic conduit fittings.

### All Weather — ENT Blue

Recommended pipe application and sizes	Set-up time (Evaporation Rate)	Recommended installation temp.	Lap Shear @ 73°F	Viscosity at 75°F as manufactured
Required for use with Flex-Plus ENT (Electrical Non-Metallic Tubing), Riser-Gard, P&C Flex and Carlon PVC fittings. Up through 6" diameter.	-5°–10°F	6–8 Minutes	2 Hrs.	350 PSI
	10°–30°F	4–5 Minutes	16 Hrs.	800 PSI
	30°–50°F	3–4 Minutes	72 Hrs.	1500 PSI
	50°–70°F	1–2 Minutes		
	70°–90°F	½–1½ Minutes		

Cat. No.	Size	Applicator	Description	Std. Ctn.	Std. Wt. (lbs.)
VC9992	Quart	Dauber	All-Weather "Quick-Set" Blue	12	29.0

Meets ASTM D-2564.

## Concrete sleeves

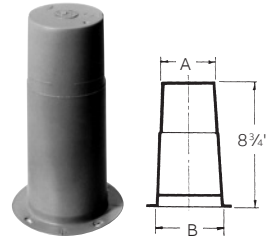

Non-metallic concrete sleeve forms are the easy way to form holes in concrete. They install in seconds with nails, screws or staples and are easily removed. Concrete will not adhere to them. Concrete sleeves are adjustable to any slab thickness.

Cat. No.	Min. O.D. A (in.)	B (in.)	Std. Ctn.	Std. Wt. (lbs.)
E92CSH	1½	1¾	20	3
E92CSJ	2	2 <sup>13</sup> / <sub>32</sub>	25	6
E92CSL	3	3 <sup>13</sup> / <sub>32</sub>	25	8
E92CSN	4	4 <sup>13</sup> / <sub>32</sub>	18	8
E92CSP	5	5 <sup>13</sup> / <sub>32</sub>	15	8
E92CSR	6	6 <sup>13</sup> / <sub>32</sub>	12	8

# Carlton®

## Plenum-Gard® Raceway

01 Applications: Plenum, riser and general purpose

Plenum-Gard is a UL® Listed non-metallic corrugated flexible conduit for use in plenum, riser and general purpose applications. Plenum-Gard is manufactured from PVDF resin, which is extremely durable and resistant to abrasion and mechanical damage before/after cable installation.

Plenum-Gard is listed to UL® 2024 in accordance with the National Electrical Code® for plenum, riser, general purpose and other cabling/optical fiber/telecommunication applications as defined in Articles 725, 770, 800 and 820.

Important: Installed cables must be plenum rated and the UL® Listing must be printed on the product. Abandoned cables MUST be removed (reference NEC®).

- Storage: -4° to 158°F
- Handling: -4° to 104°F
- No UV protection (not suitable for outdoor use)
- Do not store outside

### Standard stock – reels

Cat. No.	Size (in.)	Color	Pull tape	Reel size (F x W) (in.)	Reel type	Reel length (ft.)	Reel Wt. (lbs.)	Reel Wt. per 100 Ft. (lbs.)
CD4X1C-1500	½	Orange	200 lb.	34 x 23	Wood	1,500	30	7
CE4X1-1000		Orange	Empty	34 x 23	Wood	1,000	30	8
CE4X1-1000S	¾	Orange	Empty/Split	34 x 23	Wood	1,000	30	8
CE4X1C-1000		Orange	900 lb.	34 x 23	Wood	1,000	30	8
CF4X1C-500		Orange	900 lb.	34 x 23	Wood	500	30	10
CF4X1C-1000		Orange	900 lb.	48 x 28	Wood	1,000	79	10
CF4X1C-1500	1	Orange	900 lb.	48 x 28	Wood	1,500	79	10
CF4X1C-5200		Orange	900 lb.	66 x 41	Wood	5,200	250	10
CF4X1C-6500		Orange	900 lb.	72 x 41	Wood	6,500	310	10
CF4X1C-8000		Orange	900 lb.	82 x 41	Wood	8,000	365	10
CG4X1C-500		Orange	900 lb.	48 x 28	Wood	500	79	14
CG4X1-500S		Orange	Empty/Split	48 x 28	Wood	500	79	10
CG4X1C-900		Orange	900 lb.	48 x 45	Wood	900	96	14
CG4X1C-1600	1¼	Orange	900 lb.	48 x 45	Wood	1,600	96	14
CG4X1C-3200		Orange	900 lb.	66 x 41	Wood	3,200	250	14
CG4X1C-6500		Orange	900 lb.	96 x 41	Wood	6,500	700	14
CG4X1-900S		Orange	Empty/Split	48 x 28	Wood	900	79	14
CH4X1C-350		Orange	900 lb.	48 x 28	Wood	350	79	16
CH4X1C-1200	1½	Orange	900 lb.	48 x 45	Wood	1,200	96	16
CH4X1C-4000		Orange	900 lb.	82 x 41	Wood	4,000	365	16
CJ4X1-200S		Orange	Empty/Split	48 x 28	Wood	200	79	21
CJ4X1C-225		Orange	900 lb.	48 x 28	Wood	225	79	21
CJ4X1C-700	2	Orange	900 lb.	48 x 45	Wood	700	96	21
CJ4X1C-1400		Orange	900 lb.	82 x 41	Wood	1,400	365	21
CJ4X1C-2000		Orange	900 lb.	82 x 41	Wood	2,000	365	21
CJ4X1C-2800		Orange	900 lb.	82 x 41	Wood	2,800	365	21
CL4X1C-150	3	Orange	900 lb.	48 x 45	Wood	150	96	41



### Technical Info

Cat. No.	Size (in.)
Maximum flame propagation	5 ft.
Maximum peak optical smoke density	0.5
Maximum average optical smoke density	0.15

NEC and National Electrical Code are registered trademarks of the National Fire Protection Association, Inc.





# Carlton

## Plenum-Gard Raceway

### Features and benefits:

- For use in plenum areas per NEC® Articles 725, 770, 800 and 820
- Sizes ½” through 3”
- Pre-installed pull tape available in sizes ½” through 3”
- Outside diameters meet IPS dimensions
- UL® Listed raceway meeting UL 2024
- Footage sequentially marked
- Single-peak design

### Standard stock – coils

Cat. No.	Size (in.)	Color	Pull tape	Coil length (ft.)	Product Wt. per 100 ft.(lbs.)
CD4X1C-500	½	Orange	900 lb.	500	7
CE4X1-350*	¾	Orange	Empty	350	8
CE4X1-350S		Orange	Empty/Split	350	8
CF4X1C-100*		Orange	900 lb.	100	10
CF4X1-100S*		Orange	Empty/Split	100	10
CF4X1C-250*	1	Orange	900 lb.	250	10
CF4X1-250		Orange	Empty	250	10
CF4X1-250S*		Orange	Empty/Split	250	10
CG4X1C-200*	1¼	Orange	900 lb.	200	14
CG4X1-200S		Orange	Empty/Split	200	14
CH4X1C-150*	1½	Orange	900 lb.	150	16
CH4X1-150S		Orange	Empty/Split	150	16
CJ4X1C-100*	2	Orange	900 lb.	100	21
CJ4X1-100S		Orange	Empty/Split	100	21

\* Overnight Shippable

### Specifications

Size (in.)	I.D. Min. Ref. (in.)	Min. O.D. (in.)	Max. O.D. (in.)	Min. bend radius (in.)
½	.60	.815	.835	2
¾	.74	1.025	1.045	2
1	1.00	1.292	1.312	3
1¼	1.35	1.630	1.650	3
1½	1.50	1.868	1.888	4
2	2.00	2.329	2.439	4
3	3.00	3.422	3.452	4

- Custom orders are not returnable
- Custom lengths are available in minimum order quantities of 1,000 ft.
- Custom color runs are available in minimum order quantities of 10,000 ft.

### Options:

- Color: Black, blue, gray, red, white and yellow
- Two-, three- or four-way parallel
- Split duct

### Custom orders – how to build a part number:

Position 1 Product	Position 2 Size (in.)	Position 3 Type	Position 4 Wall	Position 5 Color	Position 6 Pull line	Position 7 Length
C = Plenum-Gard	D = ½	4 = Corrugated	X = Standard	1 = Orange	C = 900 LB. Tape	Example
	E = ¾			2 = Black		-1000 = Feet
	F = 1			3 = Gray		-1000S = 1000 Feet Split
	G = 1¼			4 = White		
	H = 1½			5 = Blue		
	J = 2			7 = Yellow		
	L = 3			8 = Red		

# Carlon®

## Riser-Gard® Raceway

01 Applications: Riser and general purpose

Riser-Gard is a non-metallic flexible raceway for use in riser and general purpose applications. Riser-Gard is UL® Listed and is available with tape pre-installed. Riser-Gard is listed to UL® 2024 Standard for riser applications or optical fiber/communications raceways.

Riser-Gard is listed to UL® 2024 in accordance with the National Electrical Code® per Articles 725, 770, 800 and 820 for riser, general purpose and other cabling/optical fiber/telecommunication applications. Riser-Gard is suitable for use in vertical runs in a shaft or between floors, as well as areas other than the plenum.

Important: Installed cables must be of suitable rating for the application.

- Storage: -4° to 158°F
- Handling: -4° to 104°F
- No UV protection (not suitable for outdoor use)
- Do not store outside



### Technical Info

UL listed to 2024	Test method	Size (in.)
Maximum flame propagation	UL 2024	6.0 ft.
Maximum air temperature at 12 ft	UL 2024	0.15

NEC and National Electrical Code are registered trademarks of the National Fire Protection Association, Inc.



### Standard stock – reels

Cat. No.	Size (in.)	Color	Pull tape	Reel size (F x W) (in.)	Reel type	Reel length (ft.)	Reel Wt. (lbs.)	Reel Wt. per 100 Ft. (lbs.)
DE4X1-1000	¾	Orange	Empty	34 x 23	Wood	1,000	30	12
DF4X1C-500R		Orange	900 lb.	43 x 23	Wood	500	56	15
DF4X1C-1000		Orange	900 lb.	48 x 28	Wood	1,000	79	15
DF4X1C-1500		Orange	900 lb.	48 x 28	Wood	1,500	79	15
DF4X1C-2700	1	Orange	900 lb.	48 x 45	Wood	2,700	96	15
DF4X1C-5200		Orange	900 lb.	66 x 41	Wood	5,200	250	15
DF4X1C-6500		Orange	900 lb.	72 x 41	Wood	6,500	310	15
DF4X1C-7000		Orange	900 lb.	72 x 45	Steel	7,000	148	15
DF4X1C-9400		Orange	900 lb.	84 x 45	Steel	9,400	199	15
DG4X1C-900		Orange	900 lb.	48 x 28	Wood	900	79	17
DG4X1C-500R		Orange	900 lb.	48 x 23	Wood	500	56	17
DG4X1C-1500		Orange	900 lb.	48 x 45	Wood	1,500	96	17
DG4X1C-1600	1¼	Orange	900 lb.	48 x 45	Wood	1,600	96	17
DG4X1C-3200		Orange	900 lb.	66 x 41	Wood	3,200	250	17
DG4X1C-4500		Orange	900 lb.	72 x 45	Steel	4,500	148	17
DG4X1C-5600		Orange	900 lb.	82 x 41	Wood	5,600	365	17
DG4X1C-6500		Orange	900 lb.	96 x 41	Steel	6,500	700	17
DH4X1C-1200		Orange	900 lb.	48 x 45	Wood	1,200	96	22
DH4X1C-4000	1½	Orange	900 lb.	82 x 45	Steel	400	193	22
DH4X1C-4500		Orange	900 lb.	84 x 45	Steel	4,500	199	22
DJ4X1C-700		Orange	900 lb.	48 x 45	Wood	700	96	27
DJ4X1C-2000	2	Orange	900 lb.	82 x 41	Wood	200	265	27
DJ4X1C-2800		Orange	900 lb.	84 x 45	Steel	2,800	199	27
DL4X1C-750	3	Orange	900 lb.	72 x 41	Wood	750	310	27

# Carlton

## Riser-Gard Raceway

**Features and benefits:**

- For use in riser and general purpose areas per NEC\* Articles 725, 770, 800 and 820
- Riser-Gard is also suitable for direct burial, not approved for exposed applications
- UL® Listed raceway meeting UL 2024
- Available in sizes ¾" through 3"
- Pull tape can be factory pre-installed in 1" through 3"
- Outside diameters meet IPS dimensions
- Footage sequentially marked

**Standard stock – coils**

Cat. No.	Size (in.)	Color	Pull tape	Coil length (ft.)	Product Wt. per 100 ft.(lbs.)
DE4X1-350*	¾	Orange	Empty	350	12
DF4X1C-125		Orange	900 lb.	125	15
DF4X1C-250*		Orange	900 lb.	250	15
DF4X1-250	1	Orange	Empty	250	15
DF4X1C-500		Orange	900 lb.	500	15
DF4X1-250S*		Orange	Empty/Split	250	15
DG4X1-200		Orange	Empty	200	17
DG4X1-200S*	1¼	Orange	Empty/Split	200	17
DG4X1C-200*		Orange	900 lb.	200	17
DG4X1C-500		Orange	900 lb.	500	17
DH4X1-150S	1½	Orange	Empty/Split	150	22
DH4X1C-150*		Orange	900 lb.	150	22
DJ4X1-100S	2	Orange	Empty/Split	100	27
DJ4X1C-100*		Orange	900 lb.	100	27
DL4X1C-250	3	Orange	900 lb.	250	27

\* Overnight Shippable

**Specifications**

Size (in.)	I.D. Min. Ref. (in.)	Min. O.D. (in.)	Max. O.D. (in.)	Min. Bend Radius (in.)
¾	.74	1.025	1.075	5
1	.98	1.290	1.340	6
1¼	1.31	1.640	1.690	8
1½	1.54	1.880	1.930	10
2	2.00	2.350	2.400	12
3	3.00	3.422	3.452	18

- Custom orders are not returnable
- Custom lengths are available in minimum order quantities of 1,000 ft.
- Custom color runs are available in minimum order quantities of 10,000 ft.
- **Options:**
  - Color: Black, blue, gray, red, white and yellow
  - Two-, three- or four-way parallel
  - Split duct
  - Custom print line

**Custom orders – how to build a part number:**

Position 1 Product	Position 2 Size (in.)	Position 3 Type	Position 4 Wall	Position 5 Color	Position 6 Pull Line	Position 7 Length
D = Riser-Gard	E = ¾	4 = Corrugated	X = Standard	1 = Orange	C = 900 LB. Tape	Example
	F = 1			2 = Black		-1000 = Feet
	G = 1¼			3 = Gray		-1000S = 1000 Feet Split
	H = 1½			4 = White		
	J = 2			5 = Blue		
	L = 3			7 = Yellow		
				8 = Red		

# Carlton® Hal-Free Riser-Gard® Raceway

01 Applications: Riser and general purpose

Hal-Free Riser-Gard is a halogen-free non-metallic flexible raceway for use in riser and general purpose applications. In the event of a fire, this product will not release halogen elements into the air, which makes it ideal for applications in tunnels, laboratories and high-tech environments. Hal-Free Riser-Gard is listed to UL® 2024 in accordance with NEC® Articles 725, 770, 800 and 820. Custom lengths and split ducts are available upon request. Hal-Free Riser-Gard is available in white only.

#### Features:

- Free from halogen elements
- Compliant with NEC® Articles 725, 770, 800 and 820
- Available in sizes 1" through 2"
- Available in white only
- Sequentially marked footage



#### Technical Info

UL listed to 2024	Test method	Size (in.)
Maximum Flame Propagation	UL 2024	3' 6" ft.
Maximum Air Temperature	UL 2024	387°F

NEC and National Electrical Code are registered trademarks of the National Fire Protection Association, Inc.

- Storage and handling: -4° to 150°F
- No UV protection (not suitable for outdoor use)
- Do not store outside



#### Standard stock – reels

Cat. No.	Size (in.)	Color	Nom. I.D. (in.)	Nom. O.D. (in.)	Pull tape	Reel size (F x W) (in.)	Reel type	Reel length (ft.)	Reel Wt. (lbs.)	Reel Wt. per 100 Ft. (lbs.)
HF4X4C-5000	1	White	1.049	1.365	900 lb.	72" x 41"	W	5,000	310	7.5
HG4X4C-4000	1½	White	1.250	1.550	900 lb.	72" x 41"	W	4,000	310	7.5
HH4X4C-2000	1½	White	1.500	1.850	900 lb.	66" x 41"	W	2,000	250	12
HJ4X4C-2000	2	White	2.000	2.425	900 lb.	82" x 41"	W	2,000	365	21

- Custom orders are not returnable
- Custom lengths are available in minimum order quantities of 1,000 ft.

#### Custom orders – how to build a part number:

Position 1 Product	Position 2 Size (in.)	Position 3 Type	Position 4 Wall	Position 5 Color	Position 6 Pull Line	Position 7 Length
H = Hal-Free	F = 1	4 = Corrugated	X = Standard	4 = White	C = 900 lb. Tape	Example
	G = 1½					-1000 = Feet
	H = 1½					-1000S = 1000 Feet Split



## Carlton Hal-Free Riser-Gard Raceway

Recommended pipe viscosity at 75° F application and sizes	Set-up time (Evaporation rate)	Recommended installation temp	Lap Shear @ 73°F	Viscosity at 75°F as manufactured
For use with Resi-Gard, Riser-Gard, P&C Flex and Carlton PVC fittings.	10°–30° F 4–5 minutes	40° to 100° F	2 hrs. 350 psi	500–900 cps
	30°–50° F 3–4 minutes		16 hrs. 800 psi	
	50°–70° F 1–2 minutes	72 hrs. 1,500 psi		
	70°–90° F 1½–1½ minutes			
Up through 6" diameter.	70°–90° F 1½–1½ minutes			



### Low-VOC Resi-Gard- Clear

Cat. No.	Size	Applicator	Description	Std. Ctn.	Std. Wt. (lbs.)
VC9963SC	Pint	Brush	Resi-Gard solvent cement clear	24	28.0

Meets ASTM D-2564.

## Non-metallic adapters and couplings

For use with Plenum-Gard

### Couplings

	Cat. No.	Size	Color	Std. Ctn.	Std. Wt. (lbs.)
	A340F	1	Orange	50	2.50

### Threaded adapters

	Cat. No.	Size	Color	Std. Ctn.	Std. Wt. (lbs.)
	A343F	1	Orange	50	1.55

### Snap-in adapters

	Cat. No.	Size	Color	Std. Ctn.	Std. Wt. (lbs.)
	A353F	1	Orange	50	3.00

## Non-metallic adapters and couplings

For use with Riser-Gard and general purpose

### Couplings

	Cat. No.	Size	Color	Std. Ctn.	Std. Wt. (lbs.)
	SCA240E	$\frac{3}{4}$	Orange	25	.783
	SCA240F	1	Orange	20	.972

### Threaded adapters

	Cat. No.	Size	Color	Std. Ctn.	Std. Wt. (lbs.)
	SCA243E	$\frac{3}{4}$	Orange	100	2.30
	SCA243F	1	Orange	50	2.00

### Snap-in adapters

	Cat. No.	Size	Color	Std. Ctn.	Std. Wt. (lbs.)
	SCA253E	$\frac{3}{4}$	Orange	100	2.90
	SCA253F	1	Orange	50	2.30

**For use**

with Plenum-Gard

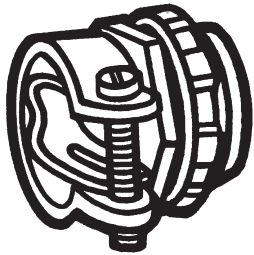

**Metallic terminal adapter**

Cat. No.	Size (in.)	Std. Ctn.	Std. Wt. (lbs.)
▶ 255	3/4	10	12
▶ 256	1	100	25
▶ 257	1 1/4	100	28
▶ 258	1 1/2	100	35
▶ 259	2	50	19



**Flat sealing washer**

Cat. No.	Size (in.)	Std. Ctn.	Std. Wt. (lbs.)
▶ E943EW	3/4	125	.45
▶ E943FW	1	100	.46
▶ E943GW	1 1/4	50	.44
▶ E943HW	1 1/2	50	.45
▶ E943JW	2	25	.42

Where a waterproof termination is required into any enclosure (metallic or non-metallic), install the neoprene washer over the threads of a terminal adapter before inserting into the enclosure. Use a standard locknut or threaded bushing to secure the assembly integrity.



**For use**

with Riser-Gard and General Purpose



For adapting non-metallic conduits to boxes, threaded fittings, metallic systems. Male threads on one end, socket end on other.

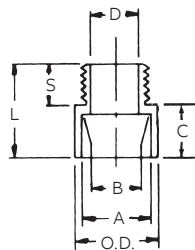

**Non-metallic male terminal adapters**

Cat. No.	Size (in.)	Std. Ctn.	Color	Dimensions (in.)							Std. Wt. (lbs.)
				Typical			Typical				
				A	B	Min. D	Max. O.D.	C	T	L	
E943E	3/4	125	Gray	1.064	1.046	.800	1 11/32	3/4	9/16	1 3/8	3.5
E943F	1	50	Gray	1.330	1.310	1.018	1 5/8	1	1 1/16	1 25/32	3
E943G	1 1/4	50	Gray	1.677	1.655	1.332	2 1/32	1	3/4	1 15/16	4
E943H	1 1/2	25	Gray	1.918	1.894	1.566	2 5/32	1 3/16	3/4	2 1/16	2.5
E943J	2	50	Gray	2.393	2.369	2.000	2 21/32	1 3/16	3/4	2 7/8	7
SCE943G	1 1/4	50	Orange	1.677	1.655	1.332	2 1/32	1	3/4	1 15/16	4
SCE943H	1 1/2	25	Orange	1.918	1.894	1.566	2 5/32	1 3/16	3/4	2 1/16	2.5
SCE943J	2	50	Orange	2.393	2.369	2.000	2 21/32	1 3/16	3/4	2 7/8	7



All socket fittings should be attached Using Carlon solvent cement. Using Carlon fittings with Carlon non-metallic conduit ensures system integrity.

Socket type for joining non-metallic conduit.

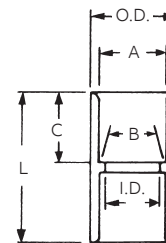

**Non-metallic standard couplings**

Cat. No.	Size (in.)	Std. Ctn.	Color	Dimensions (in.)						Std. Wt. (lbs.)
				Typical		Max.	Typical			
				A	B	Min. D	O.D.	C	L	
E940E	3/4	100	Gray	1.064	1.046	.840	1 5/16	3/4	1 5/8	4.4
E940F	1	50	Gray	1.330	1.310	1.210	1 5/8	1 5/16	2	3.5
E940G	1 1/4	30	Gray	1.677	1.655	1.535	1 63/64	1	2 1/8	3.5
E940H	1 1/2	25	Gray	1.918	1.894	1.755	2 15/64	1 1/8	2 3/8	3.9
E940J	2	30	Gray	2.393	2.369	2.190	2 47/64	1 3/16	2 1/2	5.25
SCE940G	1 1/4	30	Orange	1.677	1.655	1.535	1 63/64	1	2 1/8	3.5
SCE940H	1 1/2	25	Orange	1.918	1.894	1.755	2 15/64	1 1/8	2 3/8	3.9
SCE940J	2	30	Orange	2.393	2.369	2.190	2 47/64	1 3/16	2 1/2	5.25

## Low-voltage

### Boxes and brackets



Dual-voltage box/bracket\*



Cat. No.	Cover	Volume	Std. Ctn.	Std. Wt. (lbs.)
SC200DV	1-Gang	20.5 cu. in	16	6.4

\*U.S. Patent D463,376.



Low-voltage add-on bracket\*



Cat. No.	Size	Std. Ctn.	Std. Wt. (lbs.)
SC100SC	1-Gang	24	2.3

\*U.S. Patent D459,312. U.S. Patent 6,710,245. U.S. Patent 6,872,884.



Low-voltage adjustable brackets\*



Cat. No.	Size	Std. Ctn.	Std. Wt. (lbs.)
SC100ADJC	1-Gang	24	7.5
SC200ADJC	2-Gang	20	6.9

\*U.S. Patent 5,289,934.

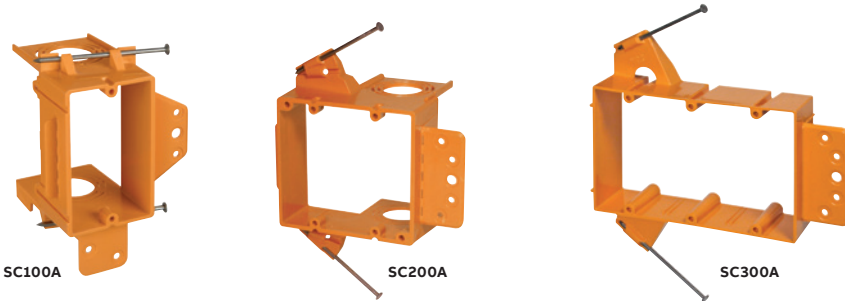

SC100A

SC200A

SC300A

Low-voltage brackets\*



Cat. No.	Cover	Volume	Std. Ctn.	Std. Wt. (lbs.)
SC100A	1-Gang	¾, 1, 1¼	24	5.3
SC200A	2-Gang	¾, 1, 1¼	24	7.7
SC300A	3-Gang	—	5	1.6

\*U.S. Patent D457,140. U.S. Patent D462,664. U.S. Patent 6,812,405.

## Resi-Gard® Flexible Raceway



Ideal for providing a main chase from the main distribution panel to a secondary hub in the attic or basement, Resi-Gard non-metallic flexible raceway is available in 3/4" to 2" diameter sizes with factory-installed pull tape in sizes 1" to 2". The raceway is hand bendable, lightweight and easily cut to length to reduce scrap. Bright orange color clearly signifies a low-voltage installation.

### Standard-length coils



Cat. No.	Size (in.)	Pull tape	Description	Reel length (ft.)
SCE4X1-100	3/4	Empty*	Flexible Raceway	100
SCF4X1C-100	1	900 lbs.	Flexible Raceway	100
SCG4X1C-100	1 1/4	900 lbs.	Flexible Raceway	100
SCH4X1C-50	1 1/2	900 lbs.	Flexible Raceway	50
SCJ4X1C-100	2	900 lbs.	Flexible Raceway	50

FT-1 Rated

\* If installing own tape, a lubricated polyester is recommended.

### Standard-length reels\*



Cat. No.	Size (in.)	Pull tape	Description	Reel length (ft.)
SCE4X1-1000	3/4	Empty	Flexible Raceway	1000
SCF4X1C-1500	1	900 lbs.	Flexible Raceway	1500
SCJ4X1C-500	2	900 lbs.	Flexible Raceway	500

\* Made to order

FT-1 Rated

## Resi-Gard fittings



### Quick-Connect couplings



E86720

Cat. No.	Size (in.)	Std. Ctn.
SCA240E	3/4	25
SCA240F	1	20



### Male terminal adapters\*



E23018

Cat. No.	Size cu. in.	Std. Ctn.
SCE943G	1 1/4	50
SCE943H	1 1/2	25
SCE943J	2	50

\* Must be cemented to Resi-Gard® Flexible Raceway using ONLY Resi-Gard® Solvent Cement.



### Quick-Connect threaded adapters



E86720

Cat. No.	Size (in.)	Std. Ctn.
SCA243E	3/4	25
SCA243F	1	20



### Standard couplings\*



E23018

Cat. No.	Size cu. in.	Std. Ctn.
SCE940G	1 1/4	30
SCE940H	1 1/2	25
SCE940J	2	30

\* Must be cemented to Resi-Gard® Flexible Raceway using ONLY Resi-Gard® Solvent Cement.



### Quick-Connect snap-in adapters



E86720

Cat. No.	Size (in.)	Std. Ctn.
SCA253E	3/4	25
SCA253F	1	20



### PVC Lock nuts



Cat. No.	Size cu. in.	Std. Ctn.
LT9E•	3/4	700
LT9F•	1	600

• UL Recognized.



# Concrete encasement guidelines for Carlon® ENT

1. Cut ENT square and clean.
2. Insert end into fitting, making sure two (2) full corrugations are snapped into fitting beyond flexible tabs (2 clicks).
3. ENT should be tied to rebar at 2–3 foot intervals to prevent flotation. Keep ENT straight. Small deflections over a long run may accumulate significant degrees of bend that will affect conductor installation. Suitable materials include wire, tie wraps and tape.
4. When using rigid non-metallic conduit fittings for concrete tight performance:

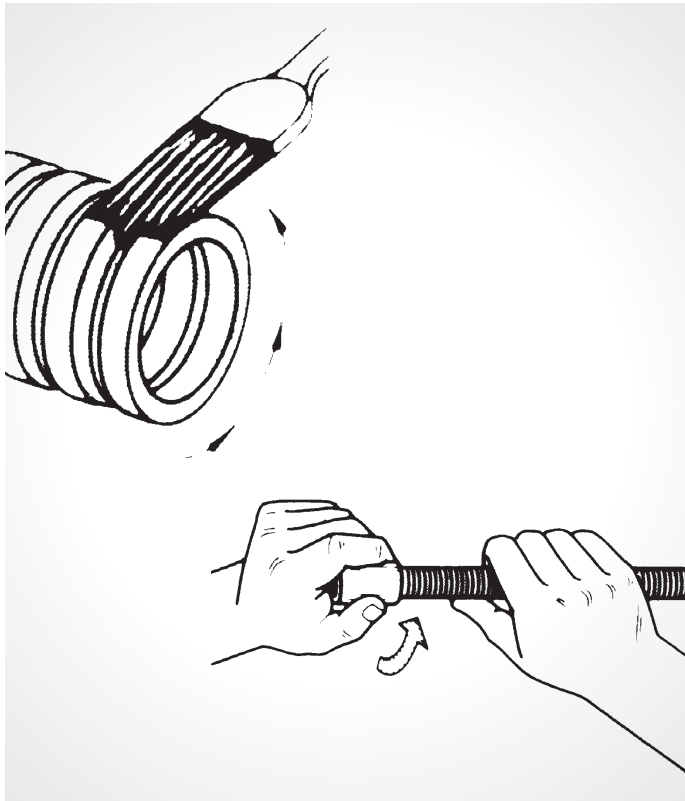

- A. Do not use chemical primer or cleaner.
- B. Use a brush to apply a light, uniform coat of cement labeled for use with ENT on the coupling and ENT.
- C. Do not use a dauber.
- D. Brush excess cement out of ENT grooves.
- E. Promptly insert ENT into fitting while cement is wet, until the stop is reached, and give a quarter turn.
- F. Do not disturb until joint is set.

## Specifications:

- 1.1 Electrical non-metallic tubing (ENT) is designed to replace EMT, flexible metal conduit or other raceway or cable systems, for installation in accordance with Article 362 of the National Electrical Code® Section 12-1500 of the CEC, other applicable sections of the Code and local codes.
- 1.2 Any ENT used shall be listed to the requirements of UL Standard UL 1653 in accordance with Article 362 of the NEC® and Section 12-1500 of the CEC.
- 1.3 Any ENT used shall meet the requirements of BI National Standard CAN/CSA-C22.2 No. 227.1-UL1653 and shall be Listed/Certified in accordance to the Electrical Codes.
- 1.4 Carlon's ENT shall be installed per the technical assessment prepared by fire cause analysis for use in 1-hour and 2-hour rated construction.
- 1.5 Penetration of fire-rated walls, floors or ceilings shall use Classified through-penetration Firestop systems described in the current Underwriters Laboratories Fire Resistance Directory.
- 1.6 Fittings and outlet boxes designed for use with ENT shall be listed. All fittings, boxes and accessories shall be from one manufacturer.
- 1.7 Only Carlon ENT Blue cement recommended specifically for use with ENT and rigid non-metallic fittings shall be used.
- 1.8 Unless indicated differently on drawings, ENT systems shall be color coded: BLUE for branch and feeder circuit wiring, YELLOW for communications and RED for fire alarm and emergency systems, or colors can designate different voltages.
- 1.9 ENT, fittings and accessories shall be manufactured by Carlon.

## Features:

- Recognized for use with PVC rigid non-metallic conduit fittings with all sizes of ENT
- ENT rated for 90°C conductors U.S., and 75°C Canada
- One-piece ENT coupling, threaded terminator and RNC transition fitting are rated concrete tight without tape
- Recognized for use in 2-hour fire-resistive nonload-bearing and load-bearing wall assemblies
- Recognized for use in 1-hour fire-resistive nonload-bearing wall assemblies
- Recognized for use in a fire-resistive ceiling assembly (up to three hours)
- Recognized for through-penetration Firestop systems as classified by UL to meet ICC building codes.
- Conductors easily push through the raceway (up to approximately 50 feet)\*
- For use in buildings in accordance with NEC® Article 362/ CEC Section 12-1500
- Outside diameters meet IPS dimensions
- Storage -4°F to 158°F
- Handling -4°F to 104°F

## Concrete encasement guidelines

for Carlon ENT (continued)

### Approved uses:

- Concrete slab – NEC® Article 362/CEC Section 12-1500
- Walls – wood stud, masonry and metal stud – NEC® Article 362/CEC Section 12-1500
- Ceilings – permanent or dropped (free air only) – NEC® Article 362/CEC Section 12-1500
- Exposed – NEC® Article 362/CEC Section 12-1500
- Public assembly – NEC® Section 518.4, in non-fire rated and certain fire rated structures
- Prewired – NEC® Article 362/CEC Section 12-1500
- Classified by UL 1479 for through penetration Firestop systems in UL Guide Category XHEZ and current UL Fire Resistance Directory
- Three-hour rated floor/ceiling assembly
- Raised floors – NEC® Section 645.5(E)(2)
- Exposed or concealed in building above three floors when a fire sprinkler system is installed in accordance with NFPA 13 – NEC® Section 362.10(2)
- For use in residential attics up to three feet above the bottom of the ceiling joist
- Maximum ambient temperature 140°F (60°C)

### Typical applications:

- Residential: low or high rise – multi or single family
- Commercial: low or high rise – office, retail, hotel/motel, restaurant, etc.
- Nursing homes/hospitals in non-patient care areas only
- Schools, classrooms, dormitories, offices
- Fire alarm systems
- Recreational vehicles and parks
- Solar photovoltaic systems
- Marinas and boatyards
- Other uses per the current NEC® and CEC

NEC and National Electrical Code are registered trademarks of the National Fire Protection Association, Inc.

## Carlon innerduct guide

When innerduct is being used inside the building...

### Plenum

- Must be UL® Listed
- Plenum cable must be installed
- Color: Industry standard orange

### General purpose and riser

- Must be UL® Listed
- Riser rated cable must be used in riser applications
- Color: Industry-standard orange

Cat. No.	Carlon size (in.)
CD4X1C	1/2
CE4X1C	3/4
CF4X1C	1
CG4X1C	1 1/4
CH4X1C	1 1/2
CJ4X1C	2
CL4X1C	3

Cat. No.	Carlon size (in.)
DE4X1C	3/4
DF4X1C	1
DG4X1C	1 1/4
DH4X1C	1 1/2
DJ4X1C	2
DL4X1C	3
CL4X1C	3

Note: HDPE innerduct will not meet code  
Specifying and installing UL Listed innerducts with the anticipation of future upgrades provides the building owner with a low-cost solution for the removal of abandoned cables.

# P&C Flex® conduit and fittings

## Carlton® P&C Flex® corrugated flexible conduit

Carlton P&C Flex non-metallic corrugated conduit makes power and communication installations faster and easier by providing maximum installation flexibility. The corrugated design is flexible enough to accommodate any degree of bend requirement. Unlike rigid conduit, it has a tight bend radius, making this product ideal for shallow trenches.

P&C Flex is manufactured to IPS dimensions and can be used with any existing conduit system using standard fittings. It is UV resistant and suitable for a variety of applications, including direct burial, under bridges, service entrance/FTTx terminations, manhole terminations, pedestal/enclosure terminations and running up utility poles or outside of buildings.

P&C Flex is available in sizes ¾" through 4", with or without pull tape (1" through 4" only) and comes in a variety of convenient standard put-ups.

### Features and benefits:

- Accommodates any degree of bend – ideal for shallow trenches
- For use with HDPE – Use ELA\_ Series fittings
- For use with PVC – Use E940\_ Series fittings
- Easily handles offsets
- Manufactured to IPS dimensions – can be used with standard IPS coupling/fittings
- UV resistant
- Can be used as a flexible sweep or raceway – one SKU can do multiple bends
- Available in sizes ¾" through 4"
- Small put-ups for easy handling

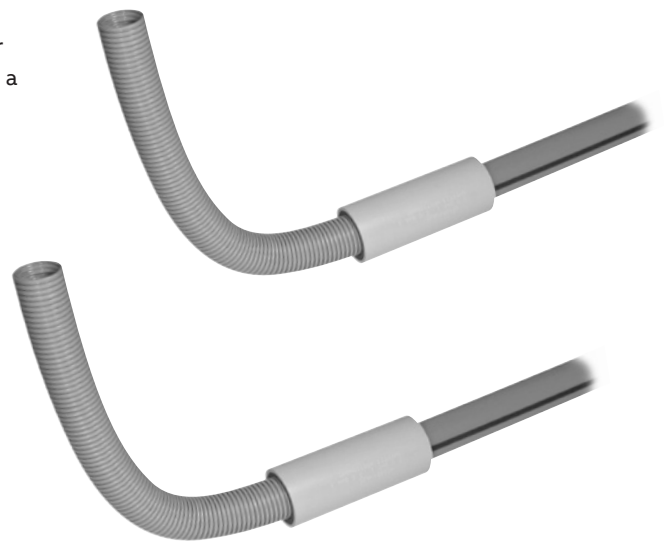

## Applications



## P&C Flex conduit and fittings

Carlson P&C Flex corrugated flexible conduit

### P&C Flex conduit

Cat. No.	Size (in.)	I.D. (in.)	O.D. (in.)	Pull tape	Reel/coil	Std. Ctn. (ft.)	Std. Wt. (lbs.)
11807-350*	¾	0.83	1.040	Empty	Coil	350	39.9
1808-250C	1	1.000	1.315	Empty	Coil	250	36.3
11808-5200	1	1.000	1.315	Empty	Reel	5200	1019.0
11809-900	1¼	1.340	1.660	Empty	Reel	900	243.0
11809-4500	1¼	1.340	1.660	Empty	Reel	4500	972.0
11810-250	1½	1.570	1.900	Empty	Reel	250	75.8
11810-4500	1½	1.570	1.900	Empty	Reel	4500	1080.0
11810T-2300	1½	1.570	1.900	1250 lb.	Reel	2300	720.0
11810T-250	1½	1.570	1.900	1250 lb.	Reel	250	78.0
11811-1100	2	2.045	2.375	Empty	Reel	1100	521.4
11811-250	2	2.045	2.375	Empty	Reel	250	87.0
11811-2500	2	2.045	2.375	Empty	Reel	2500	815.0
11811-500	2	2.045	2.375	Empty	Reel	500	201.6
11811-700	2	2.045	2.375	Empty	Reel	700	269.0
11811T-250	2	2.045	2.375	1250 lb.	Reel	250	89.0
11812-250	2½	2.469	2.875	Empty	Reel	250	121.0
11812AG-001	2½	2.469	2.875	Empty	Reel	1300	516.1
11813-1200	3	3.068	3.500	Empty	Reel	1200	850.8
11813-250	3	3.068	3.500	Empty	Reel	250	192.0
11813-500	3	3.068	3.500	Empty	Reel	500	523.0
11813-750	3	3.068	3.500	Empty	Reel	750	554.3
11815-250	4	4.026	4.500	Empty	Reel	250	324.0
11815-800	4	4.026	4.500	Empty	Reel	800	778.4

\*Pull tape not available for ¾" conduit.

## P&C Flex fittings

### Couplings

Cat. No.	Size (in.)	Std. Ctn.	Std. Wt. (lbs.)
E940E	¾	100	4.6
E940F	1	50	3.5
E940G	1¼	30	3.2
E940H	1½	25	3.4
E940J	2	30	5.3
E940K	2½	20	7.5
E940L	3	25	14.7
E940N	4	15	12.5



## P&C Flex fittings (continued)

### Female adapters

Cat. No.	Size (in.)	Std. Ctn.	Std. Wt. (lbs.)
E942E	¾	100	4.3
E942F	1	50	3.7
E942G	1¼	30	3.3
E942H	1½	25	3.3
E942J	2	30	5.4
E942K	2½	20	6.6
E942L	3	25	11.8
E942N	4	15	10.8



### Terminal adapters

Cat. No.	Size (in.)	Std. Ctn.	Std. Wt. (lbs.)
E943E	¾	125	4.2
E943F	1	50	3.0
E943G	1¼	25	4.1
E943H	1½	25	2.7
E943J	2	5	6.9
E943K	2½	20	6.3
E943L	3	45	16.6
E943N	4	15	11.7



### Bell ends (Schedule 40)

Cat. No.	Size (in.)	Std. Ctn.	Std. Wt. (lbs.)
E997F	1	50	2.6
E997G	1¼	35	2.5
E997H	1½	30	2.5
E997J	2	10	4.8
E997K	2½	10	2.0
E997L	3	10	10.0
E997N	4	30	16.0



### Plugs

Cat. No.	Size (in.)	Std. Ctn.	Std. Wt. (lbs.)
P258H	1½	50	1.7
P258JT	2	60	3.1
P258K	2½	25	1.5
P258LT	3	30	3.4
P258NT	4	48	8.3



## P&C Flex conduit and fittings

### Carlson P&C Flex corrugated flexible conduit

#### Specifications

Performance properties	3/4"	1"	1 1/4"	1 1/2"	2"	2 1/2"	3"	4"
Stiffness F/y at 5% deflection	200	200	200	200	200	130	130	90
Impact strength (ft./lbs.) 72° F	35	40	40	50	50	70	120	140
Impact strength (ft./lbs.) 32° F	5	8	8	15	25	35	60	60
Minimum bending radius (inches)	6	6	6	7	8	12	15	18
Conduit tensile strength	200	300	400	500	700	1000	1500	2000

Storage: -4° to 158° F  
 Handling: -4° to 104° F

#### Sweep and elbow conversion chart

Radius Nom. Dia. (in.)	Segment	18" required length of P&C Flex (in.)	24" required length of P&C Flex (in.)	36" required length of P&C Flex (in.)	48" required length of P&C Flex (in.)	60" required length of P&C Flex (in.)
1 1/2	90°	33	42	61	80	99
	45°	19	23	33	42	52
	30°	14	17	23	30	36
	22 1/2°	12	14	19	23	28
2	90°	32	42	61	79	98
	45°	18	23	32	42	51
	30°	14	17	23	29	35
	22 1/2°	11	12	18	23	28
2 1/2	90°	34	44	63	81	100
	45°	20	25	33	44	53
	30°	16	19	24	31	37
	22 1/2°	13	15	20	25	30
3	90°	35	44	63	82	101
	45°	20	25	34	44	53
	30°	16	19	24	32	38
	22 1/2°	13	16	20	25	30
4	90°	37	46	65	84	103
	45°	22	27	37	46	55
	30°	18	21	27	34	40
	22 1/2°	15	18	22	27	32

For other radius sweeps, use this formula:  $.0175 \times \text{radius (inches)} \times \text{angle}^\circ = \text{Required length of P\&C Flex in inches.}$

#### Technical information

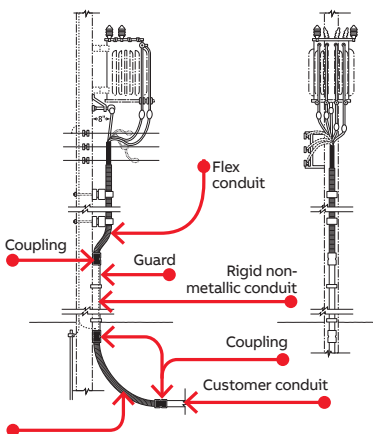

P&C Flex conduit is flexible. Carlson P&C Flex non-metallic corrugated conduit is used to transition from Carlson P&C Duct Type DB. Despite equipment being mounted away from the pole, P&C Flex conduit remains flush to the pole.

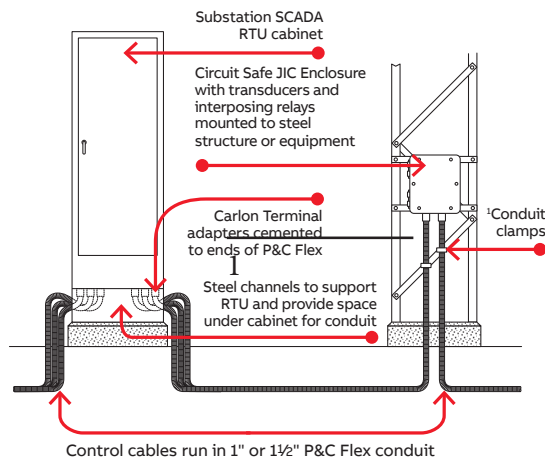

Carlson P&C Flex non-metallic corrugated conduit protects control cables in supervisory control and data acquisition equipment (SCADA) in distribution substations. Flexibility provides maximum utilization of equipment.



When soil conditions do not permit direct burial of cable, use Carlson P&C Flex non-metallic corrugated conduit to protect the cable. A lower coefficient of friction provides easy wire pulls on location. Flexibility eliminates the need for elbows.

## P&C Flex conduit and fittings

### Carlton P&C Flex corrugated flexible conduit

#### Suggested applications

- Carlton P&C Flex non-metallic corrugated conduit is the most versatile system available for power and communications applications
- P&C Flex combines high crush strength with flexibility
- Longer coil lengths reduce installation time

#### Here are a few application ideas that illustrate how P&C Flex can be effectively used:

In single-phase underground primary systems, lower the cost of direct buried and standard conduit systems by installing P&C Flex non-metallic corrugated conduit with a vibratory plow.

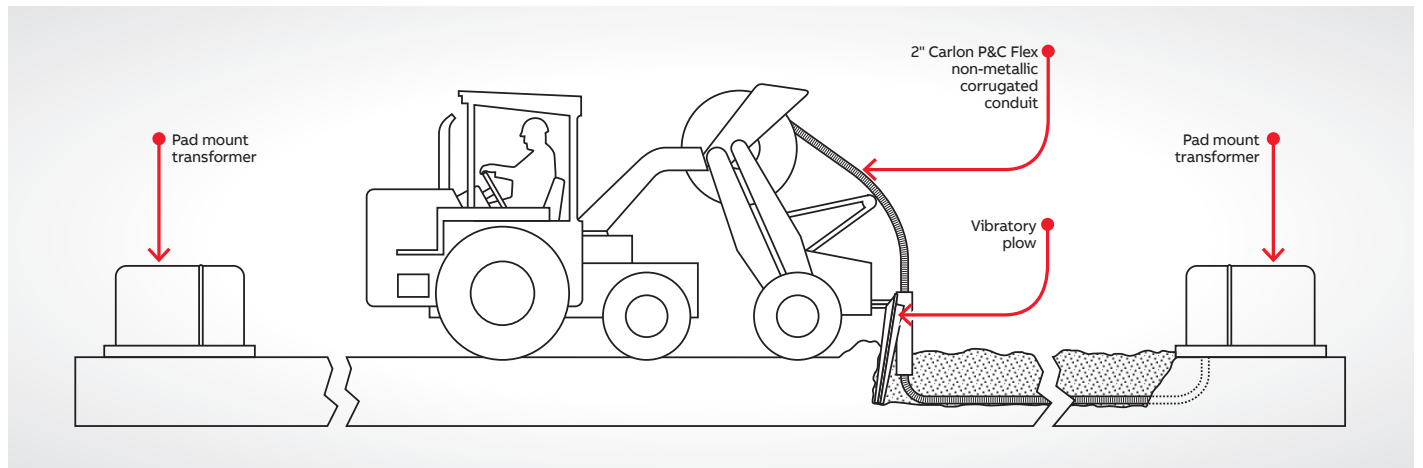

Digging up faulty cable in frozen ground can be expensive and time consuming. Use Carlton P&C Flex from the customer service raceway to the temporary service pedestal to restore power on an interim basis. When the service length is more than 250 feet, use a splice box and an additional length of P&C Flex non-metallic corrugated Conduit.

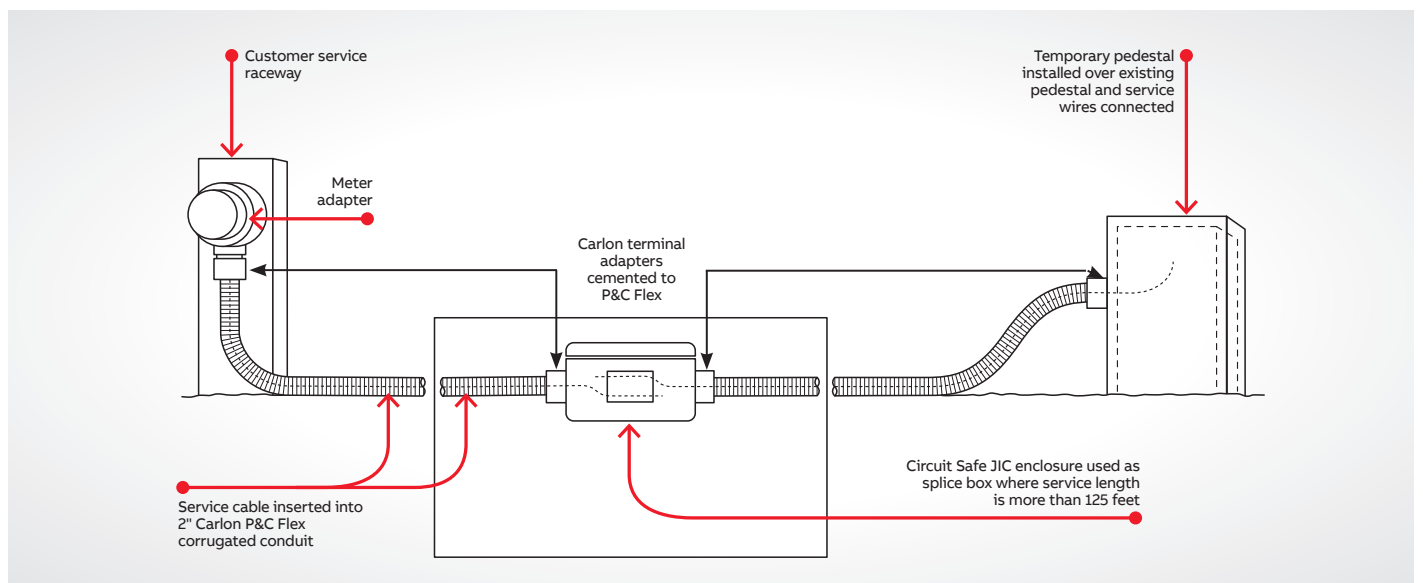



## P&C Flex conduit and fittings

Carlson P&C Flex corrugated flexible conduit

### Installation instructions

**Incorrect method**



**Correct method**



#### Trenching

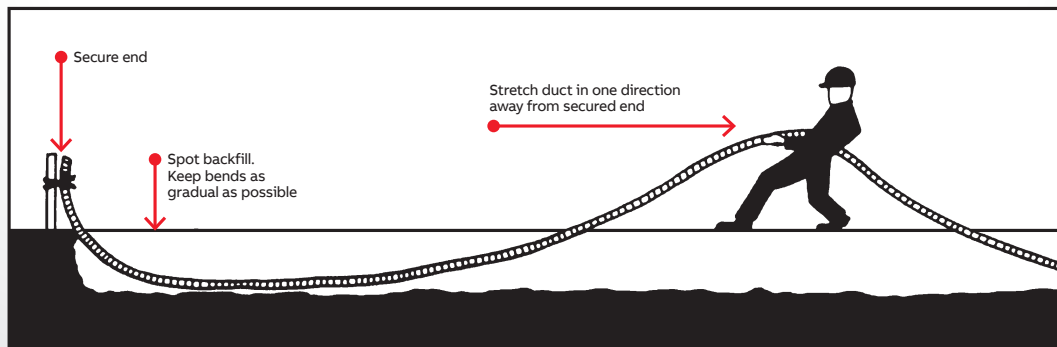

#### 1 Trenching

Trench should be graded true and free from stones or soft spots. Backfill should also be free of stones and be firmly tamped around the sides of the conduit to develop maximum supporting strength. Tamping on top of the conduit is not recommended.

#### 2 Backfill

In rocky soil where it is impossible to have an even trench bottom, a selected backfill should be put in before laying the conduit. Selected backfill (not tamped) at least 6" over the top of the conduit is recommended. After final backfill is placed, tamping may be used to finish the grade.

#### 3 Duct placement

Duct may be unreeled directly into trench or alongside trench and subsequently placed in trench. After placing in trench, secure one end and stretch it by hand to take up the slack. Spot backfill to hold in position. Do not use mechanical stretching equipment.

#### 4 Changes in direction

Avoid unnecessary turns, dips or changes in direction. Keep bends as gradual as possible to ensure ease of cable pull-in after duct installation.

#### 5 Pneumatic rodding

All commonly used vacuum or pressure rodding equipment can be used to rod P&C Flex. The line carrier (mouse, puck, rocket) should be soft, flexible material designed to fit snugly into duct without interference.

#### 6 Mechanical rodding

All commonly used mechanical rodding equipment can be used to rod P&C Flex. The tip should have a ball-type arrangement to keep rod from catching in the convolutions on the inside of duct.

# Carlon® Corrugated HDPE

—  
01 Pulled through existing conduits

Corrugated HDPE is manufactured from High Density Polyethylene (HDPE) and it is intended for innerduct applications. It's ideal for pulls under 1000ft. and is designed to reduce surface contact when pulling cable. And because this product is lightweight and offers maximum flexibility, installation in small or restricted locations is made easier. HDPE corrugated duct is available in sizes 1" through 2" and is offered in a variety of colors. Custom options are also available to satisfy the requirements of most installations.

**Applications:**

Placed inside existing ducts (innerducts)

**Installation method:**

Pulled through existing conduit



**PE Corrugated options:**

- Sizes 1" through 2"
- Sequentially marked footage
- Multiple colors and stripes
- Factory installed pull tape

**Specifications:**

Installation temperature range: -20°F to 122°F  
Handling: -20°F to 104°F

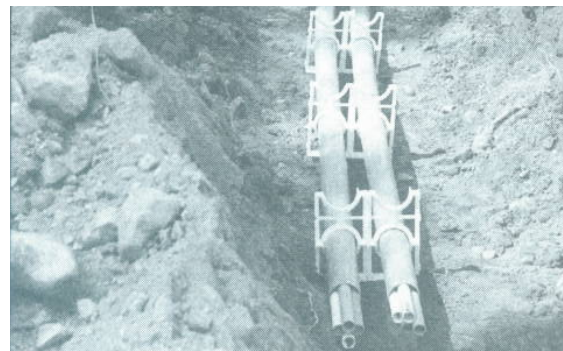

—  
01

Nominal size (in.)	Nom. I.D.	Nom. O.D.	Min. wall	Wt/ 100 (ft.)	Min bend radius (in.)	Pull tensile reel (lbs.)
1	1.260	1.340	.035	10.6	14	261
1-1/4	1.482	1.565	.035	11.2	5	319
1-1/2	1.745	1.825	.035	18.0	6	1,384
2	2.345	2.425	.035	20.8	5-1/2	493

**Custom orders**

**How to build a part number**

Position 1 Product	Position 2 Size	Position 3 Type	Position 4 Wall	Position 5 Options	Position 6 Splits	Position 7 Color	Position 8 Stripes	Position 9 Tape	Position 10 Length
A = HDPE	5 = 1" 6 = 1-1/4" 9 = 1-1/2" 13 = 2"	D = corrugated	2 = None-corr	N = None - E = Slit S = Standard 6 400	1 = 1 way 2 = 2 way 3 = 3 way 4 = 4 way 5 = 2 way 6 = 3 way 7 = 4 way	A = Black B = Blue C = Brown D = Buff E = Grey F = Green G = Lilac H = Lt. Green J = Orange K = Red L = Terra Cotta M = White N = Yellow	NN = None 1A = Black stripe 1B = Blue stripe 1C = Brown stripe 1D = Buff stripe 1E = Grey stripe 1F = Green stripe 1G = Lilac stripe 1H = Lt. Green stripe 1J = Orange stripe 1K = Red stripe 1L = Terra Cotta stripe 1M = White stripe 1n = Yellow stripe	A = empty B = 1330 lbs. polyester tape C = 1250 lbs. polyester tape E = 1800 lbs polyester tape G = 2000 lbs. polyester tape J = 2500 lbs. polyester tape	1500 (Equals 1500 ft)

Customer orders are not returnable  
Customer lengths are available in minimum order quantities. See Quote form.

# Carlton

## Corrugated HDPE

### Standard length - reels

Size	Color	Part No.	Nom. I.D.	Nom. O.D.	Pull tape (lbs.)	Reel size	Reel length (ft.)	Prod. Wt. per 10 ft. (lbs.)
1"	Orange	A5D2S1JNNB1000	1.049	1.340	1130	48-30-24	1000	12.5
	Orange	A5D2S1JNNB1800	1.049	1.340	1130	48-30-24	1800	12.5
	Orange	A5D2S1JNNB2000	1.049	1.340	1130	48-41-24	2000	12.5
	Orange	A5D2S1JNNB2700	1.049	1.340	1130	48-21-24	2700	12.5
	Orange	A5D2S1JNNB5000	1.049	1.340	1130	66-41-24	5000	12.5
	Orange	A5D2S1JNNB6500	1.049	1.340	1130	72-41-24	6500	12.5
	Orange	A5D2S1JNNB7000	1.049	1.340	1130	72-45-24	7000	12.5
	Orange	A5D2S1JNNB8000	1.049	1.340	1130	82-41-24	8000	12.5
1-1/4"	Orange	A6D2S1JNNB1000	1.250	1.565	1130	48-30-24	1000	14.4
	Orange	A6D2S1JNNB1600	1.250	1.565	1130	48-41-24	1600	14.4
	Orange	A6D2S1JNNB2500	1.250	1.565	1130	66-41-24	2500	14.4
	Orange	A6D2S1JNNB4000	1.250	1.565	1130	66-41-24	4000	14.4
	Orange	A6D2S1JNNB5000	1.250	1.565	1130	72-41-24	5000	14.4
	Orange	A6D2S1JNNB6000	1.250	1.565	1130	82-41-24	6000	14.4
	Orange	A6D2S1JNNB7000	1.250	1.565	1130	84-45-24	7000	14.4
1-1/2"	Orange	A9D2S1JNNB1000	1.500	1.825	1130	66-41-24	1000	17.8
	Orange	A9D2S1JNNB2200	1.500	1.825	1130	66-41-24	2200	17.8
	Orange	A9D2S1JNNB2900	1.500	1.825	1130	72-41-24	2900	17.8
	Orange	A9D2S1JNNB4000	1.500	1.825	1130	82-41-24	4000	17.8
2"	Orange	A13D2S1JNNB500	2.000	2.425	1130	48-30-24	500	25.0
	Orange	A13D2S1JNNB750	2.000	2.425	1130	48-41-24	750	25.0
	Orange	A13D2S1JNNB1000	2.000	2.425	1130	66-41-24	1000	25.0
	Orange	A13D2S1JNNB1500	2.000	2.425	1130	66-41-24	1500	25.0
	Orange	A13D2S1JNNB1800	2.000	2.425	1130	72-41-24	1800	25.0
	Orange	A13D2S1JNNB2000	2.000	2.425	1130	82-41-24	2000	25.0

\*Pull tape not available for 3/4" conduit.

### Standard length - coils

Size	Color	Part No.	Nom. I.D.	Nom. O.D.	Pull tape (lbs.)	Reel size	Reel length (ft.)	Prod. Wt. per 10 ft. (lbs.)
1	Orange	A5D2E1JNNA250	1.049	1.340	Empty	Coil	250/split	12.5
	Orange	A5D2E1JNNA250b	1.049	1.340	Empty	34-14-34	250/split	12.5
	Orange	A5D2S1JNNB250	1.049	1.340	1130 lb.	Coil	250	12.5
	Orange	A5D2S1JNNB250B	1.049	1.340	1130 lb.	34-14-34	250	12.5
	Orange	A5D2S1JNNB500	1.049	1.340	1130 lb.	Coil	500	12.5
	Orange	A5D2S1JNNB500B	1.049	1.340	1130 lb.	39-15-39	500	12.5
1-1/4"	Orange	A6D2E1JNNA250	1.250	1.565	Empty	Coil	250/split	14.4
	Orange	A6D2E1JNNA250B	1.250	1.565	Empty	39-15-39	250/split	14.4
	Orange	A6D2S1JNNB250	1.250	1.565	1130 lb.	Coil	250	14.4
	Orange	A6D2S1JNNB250B	1.250	1.565	1130 lb.	39-15-39	250	14.4
	Orange	A6D2S1JNNB500	1.250	1.565	1130 lb.	Coil	500	14.4
	Orange	A6D2S1JNNB500B	1.250	1.565	1130 lb.	44-18-44	500	14.4
1-1/2"	Orange	A9D2S1JNNB250	1.500	1.825	1130 lb.	Coil	250	17.8
	Orange	A9D2S1JNNB250B	1.500	1.825	1130 lb.	44-18-44	250	17.8
	Orange	A9D2S1JNNB500	1.500	1.825	1130 lb.	Coil	500	17.8
2"	Orange	A13D2S1JNNB250	2.000	2.425	1130 lb.	Coil	250	25

# Elbows, sweeps and accessories

## Carlton® PVC conduit repair system

A job that normally takes 20 minutes – DONE in two minutes or less!

The new, revolutionary design Carlton PVC Conduit Repair System significantly reduces the time and money associated with repairing broken PVC conduits, a.k.a. "stub-ups", in concrete slabs. The system includes a line of couplings, adapters, reamers and plugs designed to enable contractors to quickly and easily repair broken PVC conduits without having to chip away and repour concrete, while still maintaining the inside diameter of the conduit. Simply cut off the broken conduit, ream the I.D. of the conduit and insert a coupling or adapter. It's that easy. A job that normally takes 20 minutes can now be done in two minutes or less!

### Features:

- cULus Listed
- PVC repair fittings are listed in accordance with the NEC® and Section 352.6
- Non-metallic couplings, adapters and plugs won't rust or corrode
- Available in sizes ½" through 2"

### Benefits:

- Saves time and money
- Maintains inside diameter of conduit
- Metallic reamers for extra strength, durability and longer life
- Quickly and easily repair broken PVC conduits

NEC and National Electrical Code are registered trademarks of the National Fire Protection Association, Inc.

—  
01



—  
02



—  
03



## Elbows, sweeps and accessories

### Carlson PVC conduit repair system

#### Male threaded adapters



Cat. No.	Trade size (in.)	Std. Ctn.
E920D	1/2	25
E920E	3/4	25
E920F	1	15
E920G	1 1/4	10
E920H	1 1/2	10
E920J	2	10

#### Reamers



Reamer



Reamer Kit

Cat. No.	Trade size (in.)	Std. Ctn.
E910REAMD	1/2	12
E910REAME	3/4	12
E910REAMF	1	10
E910REAMG	1 1/4	10
E910REAMH	1 1/2	10
E910REAMJ	2	10
E910REAMKIT	All Sizes	5

#### Couplings



Cat. No.	Trade size (in.)	Std. Ctn.
E910D	1/2	25
E910E	3/4	25
E910F	1	15
E910G	1 1/4	10
E910H	1 1/2	10
E910J	2	10

#### Schedule 40 plugs



Cat. No.	Size (in.)	Color	Cat. No.	Size (in.)	Color	Cat. No.	Size (in.)	Color	Std. Ctn.
HL-6XR	1/2	Red	HL-6XB	1/2	Blue	HL-6XY	1/2	Yellow	1 Bag of 50
HL-10R	3/4	Red	HL-10B	3/4	Blue	HL-10Y	3/4	Yellow	1 Bag of 50
HL-13AR	1	Red	HL-13AB	1	Blue	HL-13AY	1	Yellow	1 Bag of 50
HL-16R	1 1/4	Red	HL-16B	1 1/4	Blue	HL-16Y	1 1/4	Yellow	1 Bag of 50
HL-18R	1 1/2	Red	HL-18B	1 1/2	Blue	HL-18Y	1 1/2	Yellow	1 Bag of 50
HL-21R	2	Red	HL-21B	2	Blue	HL-21Y	2	Yellow	1 Bag of 50



## Elbows, sweeps and accessories

### PVC conduit repair system instructions

01 Cut broken conduit off flush.

02 Insert plug to keep conduit clean/dry through balance of rough-in. Once rough-in is complete, remove plug and **continue with Step 3.**

03 With reamer tool and standard 1/2" drill, ream I.D. of conduit. It is recommended to use a variable speed drill. Use slower speed to avoid overheating the conduit.

04 The guide will direct the cutter; the stop will touch when completed.

05 Insert the coupling and cement into place using the cement manufacturer's instructions below.

A. Clean socket I.D. and spigot O.D. of dirt and moisture.

B. Apply a uniform coat of cement to spigot end and push onto socket bottom, rotating 1/4 turn.

C. Allow time to set before disturbing. This will depend upon temperature.

01



02

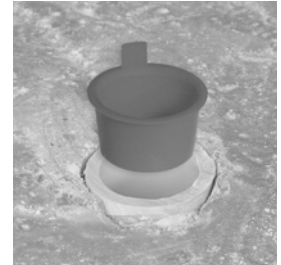

03



04

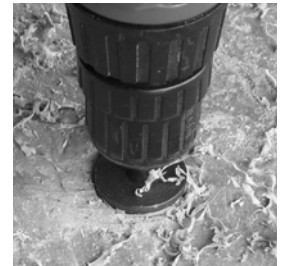

#### Alternative to conduit repairs:

Prior to concrete pour, measure and saw cut all conduit stub-ups to the thickness of the concrete pour. Insert plugs. Pour concrete flush to the conduit. When pour is complete, remove plugs and proceed with Step 3. This alternative method saves time/money by eliminating the need for transitions or use of metal elbows.

05



Apply a uniform coat of cement.



Insert fitting.



Rotate quarter turn.

## Carlton rigid non-metallic conduit (RNC) fittings and accessories

Carlton Schedule 40 and Schedule 80 fittings are designed for use aboveground and underground as described in the National Electrical Code®.

- **Ease of installation** – Non-metallic fittings are 1/4 to 1/5 the weight of metallic systems, can be installed in less than half the time and are easily fabricated on the job.
- **Safety** – Non-metallic fittings are nonconductive, assuring a safe system.
- **Impact Resistant** – Schedule 40 and Schedule 80 non-metallic fittings are resistant to sunlight and are listed for exposed for outdoor usage. The use of expansion fittings allows the system to expand and contract with temperature variations.
- **Corrosion Resistant** – Carlton fittings are non-metallic and will not rust or corrode. Carlton non-metallic Schedule 40 and Schedule 80 elbows are manufactured to NEMA TC-2, Federal specification WC1094A and UL 651 specifications. Fittings are manufactured to NEMA TC-3, Federal specification WC1094A and UL514B. Both conduit and fittings carry respective UL or ETL Listings and UL or ETL labels.



# Elbows, sweeps and accessories

## Schedule 40 elbows – standard radius



Item	Cat. No.	Box type included	Size (in.)	Plain end Std. Ctn.	Belled end Std. Ctn.	
<b>90° elbow</b>	UA9AD	UA9ADB	1/2	50	50	
	UA9ADR-CAR	UA9ADB	1/2	25	50	
	UA9AE	UA9AEB	3/4	25	25	
	UA9AFR-CTN	UA9AFB-CTN	1	25	25	
	UA9AG	UA9AGB	1 1/4	20	20	
	UA9AH	UA9AHB	1 1/2	25	25	
	UA9AJ	UA9AJB	2	20	20	
	UA9AK-CAR	UA9AKB-CAR	2 1/2	10	10	
	UA9AL	UA9ALB	3	1	5	
	UA9AM	UA9AMB	3 1/2	1	20	
	UA9AN	UA9ANB	4	1	1	
	UA9AP	UA9APB	5	1	1	
	UA9AR	UA9ARB	6	1	1	
	<b>45° elbow</b>	UA7AD	UA7ADB	1/2	50	50
		UA7AE	UA7AEB	3/4	25	25
UA7AF		UA7AFB	1	20	20	
UA7AF-CAR		UA7AFB	1	15	20	
UA7AG		UA7AGB	1 1/4	20	20	
UA7AH		UA7AHB	1 1/2	20	20	
UA7AJ		UA7AJB	2	20	20	
UA7AJ-CAR		—	2	4	—	
UA7AK		UA7AKB	2 1/2	20	20	
UA7AL		UA7ALB	3	5	25	
UA7AM		UA7AMB	3 1/2	1	20	
UA7AN		UA7ANB	4	1	20	
UA7AP		UA7APB	5	1	1	
UA7AR		UA7ARB	6	1	1	
<b>30° elbow</b>		UA6AD	UA6ADB	1/2	50	50
	UA6AE	UA6AEB	3/4	25	25	
	UA6AF	UA6AFB	1	25	1	
	UA6AG	UA6AGB	1 1/4	20	20	
	UA6AH	UA6AHB	1 1/2	25	1	
	UA6AJ	UA6AJB	2	20	20	
	UA6AK	UA6AKB	2 1/2	10	20	
	UA6AL	UA6ALB	3	1	1	
	UA6AM	UA6AMB	3 1/2	1	1	
	UA6AN	UA6ANB	4	1	1	
	UA6AP	UA6APB	5	1	1	
	UA6AR	UA6ARB	6	1	1	
	<b>22 1/2° elbow</b>	UA5AD	—	1/2	1	—
		UA5AE	—	3/4	1	—
		UA5AF	—	1	1	—
UA5AG		—	1 1/4	1	—	
UA5AH		—	1 1/2	1	—	
UA5AJ		UA5AJB	2	25	1	
UA5AK		—	2 1/2	20	—	
UA5AL		UA5ALB	3	5	1	
UA5AM		—	3 1/2	1	—	
UA5AN		UA5ANB	4	1	1	
UA5AP		UA5APB	5	1	1	
UA5AR		UA5ARB	6	1	1	

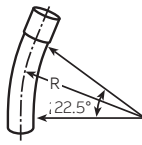
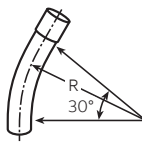
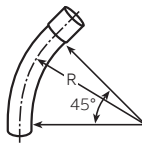
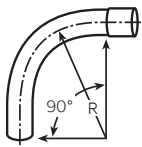

Item	Cat. No.	Box type included	Size	Plain end Std. Ctn.	Belled end Std. Ctn.
<b>11 1/4° elbow</b>	UA3AD	—	1/2	1	—
	UA3AE	—	3/4	1	—
	UA3AF	—	1	1	—
	UA3AG	—	1 1/4	1	—
	UA3AH	—	1 1/2	1	—
	UA3AJ	—	2	1	—
	UA3AK	—	2 1/2	1	—
	UA3AL	—	3	1	—
	UA3AM	—	3 1/2	1	—
	UA3AN	UA3ANB	4	1	1
	UA3AP	—	5	1	—
	UA3AR	—	6	1	—

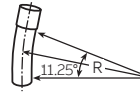

Available in plain and integral belled end for use with non-metallic solvent weld fittings.

### Standard radius elbow dimensions (per NEC®)

Size (in.)	B Minus (Radius) (in.)	C Min. (in.)
1/2	.840	4
3/4	1.050	4 1/2
1	1.315	5 3/4
1 1/4	1.660	7 1/4
1 1/2	1.900	8 1/4
2	2.375	9 1/2
2 1/2	2.875	10 1/2
3	3.500	13
3 1/2	4.000	15
4	4.500	16
5	5.563	24
6	6.625	30

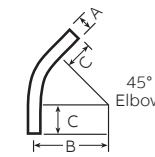
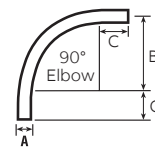

### Integral belled end dimensions

Trade Size (in.)	A (in.) at Entrance		B (in.) at Bottom		C (in.) Socket Depth	
	Max.	Min.	Max.	Min.	Max.	Min.
1/2	0.86	0.844	0.844	0.828	1.500	0.652
3/4	1.074	1.054	1.056	1.036	1.500	0.719
1	1.340	1.320	1.320	1.300	1.875	0.875
1 1/4	1.689	1.665	1.667	1.643	2.000	0.938
1 1/2	1.930	1.906	1.906	1.882	2.000	1.062
2	2.405	2.381	2.381	2.357	2.000	1.125
2 1/2	2.905	2.875	2.883	2.853	3.000	1.469
3	3.530	3.500	3.507	3.477	3.125	1.594
3 1/2	4.065	3.965	4.007	3.977	3.250	1.687
4	4.565	4.465	4.506	4.476	3.375	1.750
5	5.643	5.543	5.583	5.523	3.625	1.937
6	6.708	6.608	6.644	6.584	3.750	2.125

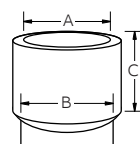

NEC and National Electrical Code are registered trademarks of the National Fire Protection Association, Inc.

## Elbows, sweeps and accessories

### Schedule 40 elbows – special radius

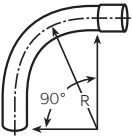

Segment	Plain end Cat. No.	Belled end Cat. No.	Nom. Dia. (in.)	Radius (in.)	Plain end Std. Ctn.	Belled end Std. Ctn.
90° elbow 	UA9CF	UA9CFB	1	18	1	1
	UA9DF	UA9DFB	1	24	1	1
	UA9EF	UA9EFB	1	30	1	1
	UA9FF	-	1	36	1	-
	UA9HF	-	1	48	1	-
	UA9CG	UA9CGB	1 1/4	18	1	1
	UA9DG	UA9DGB	1 1/4	24	1	1
	UA9FG	UA9FGB	1 1/4	36	1	1
	UA9HG	-	1 1/4	48	1	-
	UA9CH	UA9CHB	1 1/2	18	1	1
	UA9DH	UA9DHB	1 1/2	24	1	1
	UA9EH	-	1 1/2	30	1	1
	UA9FH	UA9FHB	1 1/2	36	1	1
	UA9HH	-	1 1/2	48	1	-
	UA9CJ	UA9CJB	2	18	1	1
	UA9DJ	UA9DJB-UPC	2	24	1	1
	UA9EJ	UA9EJB	2	30	1	1
	UA9FJ-UPC	UA9FJB	2	36	1	1
	UA9HJ	UA9HJB	2	48	1	1
	UA9JJ	-	2	72	1	-
	UA9CK	UA9CKB	2 1/2	18	1	1
	UA9DK	UA9DKB-UPC	2 1/2	24	1	1
	UA9EK	UA9EKB	2 1/2	30	1	1
	UA9FK-UPC	UA9FKB	2 1/2	36	1	1
	UA9HK	UA9HKB	2 1/2	48	1	1
	UA9CL	UA9CLB	3	18	1	1
	UA9DL	UA9DLB-UPC	3	24	1	1
	UA9EL	UA9ELB	3	30	1	1
	UA9FL	UA9FLB	3	36	1	1
	UA9HL	UA9HLB	3	48	1	1
	UA9IL	-	3	60	1	-
	UA9DM	UA9DMB	3 1/2	24	1	1
	UA9FM	UA9FMB	3 1/2	36	1	1
	UA9HM	UA9HMB	3 1/2	48	1	1
	-	UA9CNB	4	18	-	1
	UA9DN	UA9DNB	4	24	1	1
UA9EN	UA9ENB	4	30	1	1	
UA9FN	UA9FNB	4	36	1	1	
UA9HN	UA9HNB	4	48	1	1	
UA9IN	UA9INB	4	60	1	1	
UA9JN	-	4	72	1	-	
UA9EP	UA9EPB	5	30	1	1	
UA9FP	UA9FPB	5	36	1	1	
UA9HP	UA9HPB	5	48	1	1	
UA9IP	UA9IPB	5	60	1	1	
UA9FR	UA9FRB	6	36	1	1	
UA9HR	UA9HRB	6	48	1	1	
UA9IR	UA9IRB	6	60	1	1	
UA9HT*	-	8	48	1	-	

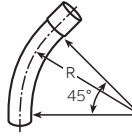
Segment	Plain end Cat. No.	Belled end Cat. No.	Nom. Dia. (in.)	Radius (in.)	Plain end Std. Ctn.	Belled end Std. Ctn.
45° elbow 	UA7CF	-	1	18	1	-
	UA7DF	-	1	24	1	-
	UA7FF	-	1	36	1	-
	UA7CG	-	1 1/4	18	1	-
	UA7DG	-	1 1/4	24	1	-
	UA7FG	-	1 1/4	36	1	-
	UA7HG	-	1 1/4	48	1	-
	UA7CH	-	1 1/2	18	1	-
	UA7DH	-	1 1/2	24	1	-
	UA7FH	UA7FHB	1 1/2	36	1	1
	UA7HH	-	1 1/2	48	1	-
	-	UA7BJB	2	12	-	1
	UA7CJ	UA7CJB	2	18	1	1
	UA7DJ	UA7DJB	2	24	1	1
	UA7FJ	UA7FJB	2	36	1	1
	UA7HJ	UA7HJB	2	48	1	1
	UA7CK	-	2 1/2	18	1	-
	UA7DK	UA7DKB	2 1/2	24	1	1
	UA7FK	UA7FKB	2 1/2	36	1	1
	UA7HK	-	2 1/2	48	1	-
	UA7CL	UA7CLB	3	18	1	1
	UA7DL	UA7DLB	3	24	1	1
	UA7FL	UA7FLB	3	36	1	1
	UA7HL	UA7HLB	3	48	1	1
	UA7DM	-	3 1/2	24	1	-
	UA7DN	UA7DNB	4	24	1	1
	UA7EN	UA7ENB	4	30	1	1
	UA7FN	UA7FNB	4	36	1	1
	UA7HN	UA7HNB	4	48	1	1
	-	UA7NNB	4	120	-	1
	UA7EP	UA7EPB	5	30	1	1
	UA7FP	UA7FPB	5	36	1	1
	UA7HP	UA7HPB	5	48	1	1
	-	UA7IPB	5	60	-	1
	-	UA7NPB	5	120	-	1
	-	UA7SPB	5	150	-	1
UA7FR	UA7FRB	6	36	1	1	
UA7HR	UA7HRB	6	48	1	1	
UA7FT*	-	8	36	1	-	
UA7HT*	-	8	48	1	-	

Note: Elbows 72" and larger may be shipped in segments. Consult factory for specifics.  
\* 8" elbows are not UL Listed.

## Elbows, sweeps and accessories

Schedule 40 elbows – special radius (continued)

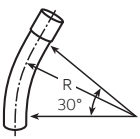
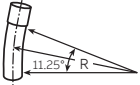

Segment	Plain end Cat. No.	Belled end Cat. No.	Nom. Dia. (in.)	Radius (in.)	Plain end Std. Ctn.	Belled end Std. Ctn.	
<b>30° elbow</b> 	UA6CJ	–	2	18	1	–	
	UA6DJ	UA6DJB	2	24	1	1	
	UA6FJ	UA6FJB	2	36	1	1	
	UA6HJ	UA6HJB	2	48	1	1	
	UA6DK	–	2½	24	1	–	
	UA6CL	–	3	18	1	–	
	UA6DL	UA6DLB	3	24	1	1	
	UA6FL	UA6FLB	3	36	1	1	
	UA6HL	–	3	48	1	1	
	UA6FM	–	3½	36	1	–	
	UA6DN	–	4	24	1	–	
	UA6FN	UA6FNB	4	36	1	1	
	UA6HN	UA6HNB	4	48	1	1	
	UA6FP	UA6FPB	5	36	1	1	
	UA6HP	UA6HPB	5	48	1	1	
	UA6FR	UA6FRB	6	36	1	1	
	UA6HR	UA6HRB	6	48	1	1	
	<b>11¼° elbow</b> 	UA3DJ	UA3DJB	2	24	1	25
		UA3FJ	UA3FJB	2	36	1	1
		UA3FL	UA3FLB	3	36	1	1
UA3HL		–	3	48	1	–	
UA3DN		UA3DNB	4	24	1	1	
UA3FN		UA3FNB	4	36	1	1	
–		UA3SNB	4	150	–	1	
UA3HN		UA3HNB	4	48	1	1	
UA3FP		UA3FPB	5	36	1	1	
UA3HP		–	5	48	1	–	
UA3FR		UA3FRB	6	36	1	1	
UA3HR		–	6	48	1	–	

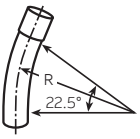
Segment	Plain end Cat. No.	Belled end Cat. No.	Nom. Dia. (in.)	Radius (in.)	Plain end Std. Ctn.	Belled end Std. Ctn.
<b>22½° elbow</b> 	UA5FF	–	1	36	1	–
	UA5FH	–	1½	36	1	1
	UA5CJ	–	2	18	1	1
	UA5DJ	UA5DJB	2	24	1	25
	UA5EJ	–	2	30	1	1
	UA5FJ	UA5FJB	2	36	1	1
	UA5CK	–	2½	18	1	–
	UA5EK	–	2½	30	1	–
	UA5FK	–	2½	36	1	–
	–	UA5CLB	3	18	–	1
	UA5DL	UA5DLB	3	24	1	1
	UA5FL	UA5FLB	3	36	1	1
	UA5HL	–	3	48	1	–
	UA5DM	–	3½	24	1	–
	UA5DN	UA5DNB	4	24	1	1
	UA5EN	–	4	30	1	1
	UA5FN	UA5FNB	4	36	1	1
	UA5HN	UA5HNB	4	48	1	1
	UA5IN	–	4	60	1	–
	–	UA5SNB	4	150	1	1
	–	UA5DPB	5	24	–	1
	–	UA5EPB	5	30	1	1
	UA5FP	UA5FPB	5	36	1	1
	UA5HP	UA5HPB	5	48	1	1
	UA5IP	–	5	60	1	–
	–	UA5UPB	5	240	–	1
UA5FR	UA5FRB	6	36	1	1	
UA5HR	UA5HRB	6	48	1	1	
UA5IR	–	6	60	1	–	
UA5HT*	–	8	48	1	–	

**Note:** Elbows 72" and larger may be shipped in segments. Consult factory for specifics.  
\* 8" elbows are not UL Listed.

# Elbows, sweeps and accessories

## Schedule 80 elbows

### Standard radius

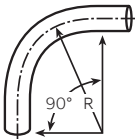
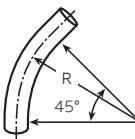
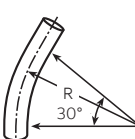
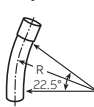
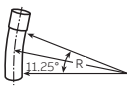
Item	Plain end Cat. No.	Belled end Cat. No.	Size (in.)	Plain	Belled end	
				end Std. Ctn.	Std. Ctn.	
 <p>90° elbow</p>	UB9AD	-	1/2	50	-	
	UB9AE	-	3/4	25	-	
	UB9AF	-	1	25	-	
	UB9AG	-	1 1/4	20	-	
	UB9AH	-	1 1/2	25	-	
	UB9AJ	-	2	20	-	
	UB9AK	-	2 1/2	10	-	
	UB9AL	-	3	5	-	
	UB9AN	-	4	1	-	
	UB9AP	UB9APB	5	1	1	
	UB9AR	-	6	1	-	
	 <p>45° elbow</p>	UB7AD	-	1/2	50	-
		UB7AE-UPC	-	3/4	25	-
UB7AF-UPC		-	1	20	-	
UB7AG		-	1 1/4	20	-	
UB7AH		-	1 1/2	20	-	
UB7AH-CAR		-	1 1/2	5	-	
UB7AJ-UPC		-	2	20	-	
UB7AK		-	2 1/2	20	-	
UB7AL		-	3	1	-	
UB7AN		-	4	1	-	
UB7AP		-	5	1	1	
UB7AR		-	6	1	-	
 <p>30° elbow</p>		UB6AD	-	1/2	50	-
	UB6AE	-	3/4	25	-	
	UB6AF	-	1	25	-	
	UB6AG	-	1 1/4	5	-	
	UB6AH	-	1 1/2	25	-	
	UB6AJ	-	2	20	-	
	UB6AK	-	2 1/2	1	-	
	UB6AL	-	3	1	-	
	UB6AN	-	4	1	-	
	UB6AP	-	5	1	-	
	UB6AR	-	6	1	-	
	 <p>22 1/2° elbow</p>	UB5AL	-	3	5	-
		UB5AN	-	4	1	-
UB5AP		-	5	1	1	
 <p>11 1/4° elbow</p>	UB3AL	-	3	1	-	

For use with non-metallic solvent weld fittings.

### Special radius

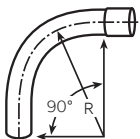
Segment	Plain end Cat. No.	Belled end Cat. No.	Nom. Dia. (in.)	Radius (in.)	Plain	Belled end
					end Std. Ctn.	Std. Ctn.
 <p>90° elbow</p>	UB9CF	-	1	18	1	-
	UB9DF	-	1	24	1	-
	UB9FF	-	1	36	1	-
	UB9CG	-	1 1/4	18	1	-
	UB9DG	-	1 1/4	24	1	-
	UB9FG	-	1 1/4	36	1	-
	UB9CH	-	1 1/2	18	1	-
	UB9DH-UPC	UB9DHB	1 1/2	24	1	1
	UB9FH	-	1 1/2	36	1	-
	UB9HH	-	1 1/2	48	1	-
	UB9CJ	-	2	18	1	-
	UB9DJ-UPC	UB9DJB	2	24	1	1
	UB9FJ	UB9FJB	2	36	1	1
	UB9HJ	-	2	48	1	-
	UB9CK	-	2 1/2	18	1	-
	UB9DK-UPC	UB9DKB	2 1/2	24	1	1
	UB9FK	UB9FKB	2 1/2	36	1	1
	UB9HK	-	2 1/2	48	1	-
	UB9CL	-	3	18	1	-
	UB9DL	UB9DLB	3	24	1	1
	UB9FL	UB9FLB	3	36	1	1
	UB9HL	-	3	48	1	-
	UB9DN	UB9DNB	4	24	1	1
	UB9FN	UB9FNB	4	36	1	1
	UB9HN	UB9HNB	4	48	1	1
	UB9NN	-	4	120	1	-
	UB9FP	-	5	36	1	-
	UB9HP	-	5	48	1	-
	UB9IP	-	5	60	1	-
	UB9FR	-	6	36	1	-
UB9HR	-	6	48	1	-	
UB9IR	-	6	60	1	-	

Note: Elbows 72" and larger may be shipped in segments. Consult factory for specifics.



# Elbows, sweeps and accessories

## Schedule 80 elbows

### Special radius (continued)

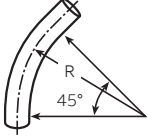

Segment	Plain end Cat. No.	Belled end Cat. No.	Nom (in.)	Radius (in.)	Plain end Std. Ctn.	Belled end Std. Ctn.
45° elbow 	UB7CF	-	1	18	1	-
	UB7DF	-	1	24	1	-
	UB7FF	-	1	36	1	-
	UB7FG	-	1 1/4	36	1	-
	UB7DH	UB7DHB	1 1/2	24	1	1
	UB7FH	-	1 1/2	36	1	-
	UB7CJ	-	2	18	1	-
	UB7DJ	UB7DJB	2	24	1	1
	UB7FJ	UB7FJB	2	36	1	1
	UB7HJ	-	2	48	1	-
	UB7FK	-	2 1/2	36	1	-
	UB7HK	-	2 1/2	48	1	-
	UB7CL	-	3	18	1	-
	UB7DL	UB7DLB	3	24	1	1
	UB7FL	UB7FLB	3	36	1	1
	UB7DN	UB7DNB	4	24	1	1
	UB7FN	UB7FNB	4	36	1	1
UB7HN	-	4	48	1	-	

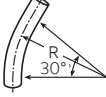
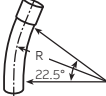
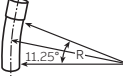
Segment	Plain end Cat. No.	Belled end Cat. No.	Nom. Dia. (in.)	Radius (in.)	Plain end Std. Ctn.	Belled end Std. Ctn.
45° elbow	UB7FP	-	5	36	1	-
	UB7FR	-	6	36	1	-
	UB7HR	-	6	48	1	-
	UB7IR	-	6	60	1	-
30° elbow 	UB6FN	-	4	36	1	-
22 1/2° elbow 	-	UB5DJB	2	24	-	20
	-	UB5FJB	2	36	-	25
	-	-	2 1/2	24	-	15
	UB5DL	-	3	24	1	10
	-	UB5FLB	3	36	-	1
	-	UB5FNB	4	36	-	1
UB5FP	-	5	36	1	-	
11 1/4° elbow 	UB3FP	-	5	36	1	-

**Note:** Elbows 72" and larger may be shipped in segments. Consult factory for specifics.

## Elbows, sweeps and accessories

### P&C duct adapters

#### Male adapter



Cat. No.	Size (in.)	Std. Ctn.
E943F	1	50
E943H	1½	25
E943J	2	50
E943L	3	50
E943N	4	20
E943P	5	5
E943R	6	10

#### Female adapter



Cat. No.	Size (in.)	Std. Ctn.
E942F	1	50
E942H	1½	25
E942J	2	30
E942L	3	25
E942N	4	15
E942P	5	8
E942R	6	6

### P&C duct swedge reducer (male x male)



Cat. No.	Size (in.)	Std. Ctn.
E252LJ	3 x 2	50
E252NJS	4 x 2	25
E252NL	4 x 3	25
E252PN	5 x 4	20
E252RNS	6 x 4	6
E252RP	6 x 5	10

### P&C duct cable marker



Cat. No.	Size (in.)	Std. Ctn.
E299JM	2 x 42	1
E299JR	2 x 78	1
E299NX7	4 x 84	1

### P&C duct end bells

#### End bell



Cat. No.	Size (in.)	Std. Ctn.
E997F	1	50
E997H	1½	30
E997J	2	40
E997L	3	50
E997N	4	30
E997P	5	15
E997R	6	10

#### Molded end bell



Cat. No.	Size (in.)	Std. Ctn.
E297J	2	40
E297L	3	50
E297N	4	30
E297P	5	15

#### Fabricated end bell



Cat. No.	Size (in.)	Std. Ctn.
E297JN	2 x 4	25
E297NT	4 x 10	15
E297PS	5 x 8	10
E297PT	5 x 10	10
E297RF	6 x 5	10

#### Long-length end bell P&C duct



Cat. No.	Size (in.)	Std. Ctn.
E297RR	6 (6 long)	10



## Elbows, sweeps and accessories

### Split sleeve coupling



Split sleeve coupling  
For joining split duct to existing duct.

#### Split sleeve coupling

Cat. No.	Size (in.)	Description	Length (in.)	Split	Std. Ctn.	Std. Wt. (lbs.)
<b>Schedule 40 and 80</b>						
E200JS6	2	Split coupling	6	1	25	6.1
E200KS7	2½	Split coupling	7	1	25	21
E200LS7	3	Split coupling	7	1	25	15.5
E200LSS*	3	Split coupling	6.5	1	25	10
E200MS8	3½	Split coupling	8	1	25	41.2
E200NS8	4	Split coupling	8	1	15	16
E200NSS*	4	Split coupling	6	2	25	17
E200PS8	5	Split coupling	8	1	15	25
E200PS9	5	Split coupling	9	1	8	16.4
E200RS1	6	Split coupling	10	1	6	24.2
<b>C Duct</b>						
E900NS8 (White)	4	C Duct split coupling	8	1	15	19
E900NSW (White)	4	C Duct split coupling	6	1	25	22

\* Two-piece design



#### Split sleeve sweeps

Cat. No.	Cat. No.	Nom. Size (in.)	Radius (in.)	Std. Ctn.	Std. Wt. (lbs.)
<b>45° Sweep</b>	UA7DJSD	2	24	1	1.4
	UA7FJSD	2	36	1	2.1
	UA7FLSD	3	36	1	4.7
	UA7HLSD	3	48	1	6.1
	UA7IJSD	2	60	1	3.2
	UA7ILSD	3	60	1	7.2
	UA7INSD	4	60	1	10.2
<b>22½° sweep</b>	UA5INSD	4	60	1	6.1
<b>11¼° Sweep</b>	UA3IJSD	2	60	1	1
	UA3INSD	4	60	1	5.1

Two 45° elbows may be segmented for 90°.

## Elbows, sweeps and accessories

### Low-VOC solvent cements



Recommended pipe viscosity at 75° F application and sizes	Set-up time (Evaporation rate)	Recommended installation temp	Lap Shear @ 73° F	Viscosity at 75° F as manufactured
Recommended for all grades and types of Carlon wireway and fittings, except Flex-Plus Blue ENT (Electrical non-metallic tubing). Up through 6" diameter.	10°–30° F Not recommended	40° to 100° F	2 hrs. 350 psi	500–900 cps
	30°–50° F 5–6 minutes		16 hrs. 800 psi	
	50°–70° F 3–4 minutes		72 hrs. 1,500 psi	
	70°–90° F 1–2 minutes			

#### Low-VOC PVC solvent cement - gray

	Cat. No.	Size	Applicator	Description	Std. Ctn.	Std. Wt. (lbs.)
	VC9LV4-24	Half pint	Dauber	Low VOC gray	24	15.5
	VVC9LV3	Pint	Dauber	Low VOC gray	24	27.0
	VC9LV2	Quart	Dauber	Low VOC gray	12	26.0

#### Low-VOC medium - clear

	Cat. No.	Size	Applicator	Description	Std. Ctn.	Std. Wt. (lbs.)
	VC9963	Pint	Dauber	PVC medium clear	24	29.0
	VC9962	Quart	Dauber	PVC medium clear	12	27.5
	VC9961P	Gallon	–	PVC medium clear	6	53.5

Meets ASTM D-2564.

#### Low-VOC medium - gray

	Cat. No.	Size	Applicator	Description	Std. Ctn.	Std. Wt. (lbs.)
	VC9923	Pint	Dauber	PVC medium gray	24	29.0
	VC9922	Quart	Dauber	PVC medium gray	12	27.5
	VC9941P	Gallon	–	PVC medium gray	6	53.5

Meets ASTM D-2564.

#### Low-VOC regular - clear

	Cat. No.	Size	Applicator	Description	Std. Ctn.	Std. Wt. (lbs.)
	VC9964	Half pint	Dauber	PVC regular clear	10	29.0

Meets ASTM D-2564. **Note:** Rated for Schedule 40 through 4" and Schedule 80 through 2".

#### Low-VOC regular - gray

	Cat. No.	Size	Applicator	Description	Std. Ctn.	Std. Wt. (lbs.)
	VC9924-24	Half pint	Dauber	PVC regular clear	24	15.0

Meets ASTM D-2564.

# Elbows, sweeps and accessories

## Primers and Low-VOC "Quick-Set" cement



**Recommended pipe application and sizes**

**Recommended installation temp**

Recommended for use with Carlon cement

5° to 100° F

**Clear primer**

	Cat. No.	Size	Applicator	Std. Ctn.	Std. Wt. (lbs.)
	VC9903	Pint	Dauber	24	27.0
	VC9902	Quart	Dauber	12	25.0

Meets ASTM F-686.

**Purple primer**

	Cat. No.	Size	Applicator	Std. Ctn.	Std. Wt. (lbs.)
	VC9932	Quart	Dauber	12	25.0

Meets ASTM F-686.

**Recommended pipe viscosity at 75° F application and sizes**

Recommended for all grades and types of Carlon wireway and fittings, except Flex-Plus Blue ENT (Electrical Non-Metallic Tubing).

Set-up time (Evaporation rate)	Recommended installation temp	Lap Shear @ 73° F	Viscosity at 75° F as manufactured
-5°-10° F 6-8 minutes	-5° to 100° F	2 hrs. 350 psi	400-700 cps
10°-30° F 4-5 minutes		16 hrs. 800 psi	
30°-50° F 3-4 minutes		72 hrs. 1,500 psi	
50°-70° F 1-2 minutes			
70°-90° F 1/2-1 1/2 minutes			

Up through 6" diameter.

**Low-VOC All Weather - clear**

	Cat. No.	Size	Applicator	Description	Std. Ctn.	Std. Wt. (lbs.)
	VC9984	Half Pint	Dauber	All weather "Quick-Set" cement	10	7
	VC9983	Pint	Dauber	All weather "Quick-Set" cement	24	30
	VC9982	Quart	Dauber	All weather "Quick-Set" cement	12	29
	VC9981P	Gallon	—	All weather "Quick-Set" cement	6	54

Meets ASTM D-2564.

## Elbows, sweeps and accessories

### Low-VOC "Quick-Set" and corrugated conduit cements

Recommended pipe viscosity at 75° F application and sizes	Set-up time (Evaporation rate)	Recommended installation temp	Lap Shear @ 73° F	Viscosity at 75° F as manufactured
Required for use with Flex-Plus Blue ENT (Electrical Non-Metallic Tubing), Riser-Gard, P&C Flex and Carlon PVC fittings.	-5°-10° F 6-8 minutes	-5° to 100° F	2 hrs. 350 psi	400-700 cps
	10°-30° F 4-5 minutes		16 hrs. 800 psi	
	30°-50° F 3-4 minutes		72 hrs. 1,500 psi	
	50°-70° F 1-2 minutes			
Up through 6" diameter.	70°-90° F 1/2-1 1/2 minutes			

#### Low-VOC all weather - ENT Blue

Cat. No.	Size	Applicator	Description	Std. Ctn.	Std. Wt. (lbs.)
VC9992	Quart	Dauber	All Weather "Quick-Set" blue	12	29.0



Meets ASTM D-2564.

Recommended pipe viscosity at 75° F application and sizes	Set-up time (Evaporation rate)	Recommended installation temp	Lap Shear @ 73° F	Viscosity at 75° F as manufactured
For use with Resi-Gard, Riser-Gard, P&C Flex and Carlon PVC fittings.	10°-30° F 4-5 minutes	40° to 100° F	2 hrs. 350 psi	500-900 cps
	30°-50° F 3-4 minutes		16 hrs. 800 psi	
	50°-70° F 1-2 minutes		72 hrs. 1,500 psi	
	70°-90° F 1/2-1 1/2 minutes			
Up through 6" diameter.	70°-90° F 1/2-1 1/2 minutes			

#### Low-VOC Resi-Gard®- Clear

Cat. No.	Size	Applicator	Description	Std. Ctn.	Std. Wt. (lbs.)
VC9963SC	Pint	Brush	Resi-Gard® solvent cement clear	24	28.0



Meets ASTM D-2564.

## Elbows, sweeps and accessories

### Installation instructions - cement joints

#### 01 Cementing PVC conduit:

1. Make square saw cut with fine-tooth saw.
2. Deburr and round inside edge of the cut end.
3. Clean socket I.D. and spigot O.D. of dirt and moisture.
4. Apply a uniform coat of cement to spigot end and push onto socket bottom, rotating  $\frac{1}{4}$  turn.
5. Allow time to set before disturbing. Setting time will depend upon temperature.

#### 02 Cementing PVC conduit: for submerged areas requiring air or water tightness:

1. Follow the procedure above for cementing conduit.
2. Test workmanship by conducting a low pressure air (3.0–5.0 psi) test after system is installed and cemented joints are set.
3. Plug and block ends to prevent movement prior to pressurization.
4. Check for leaks with soap solution.
5. Even low pressure air can cause high-thrust loads and caution must be observed.

#### 03 Cementing ENT for concrete-tight applications:

1. Use Carlon socket tight fittings or couplings.
2. Do not use chemical primer or cleaner.
3. Apply a light uniform coat of cement labeled for use with ENT.
4. Use a brush to apply the cement.
5. Brush excess cement out of ENT grooves.
6. Promptly insert ENT into fitting while cement is wet until the fitting stop is reached and give  $\frac{1}{4}$  turn.
7. Do not disturb until the joint is set.

Carlon non-metallic products are joined by means of solvent cement joints. Sizes  $\frac{1}{2}$ " through  $1\frac{1}{2}$ " should be cut square (using a fine-tooth handsaw) and deburred. For sizes 2" through 6", a miter box or similar saw guide should be utilized to keep the material steady. After cutting and deburring, wipe ends clean of dust, dirt and shavings.

#### Joining process as follows:

- Be sure that conduit end is clean and dry.
- Apply coat of Carlon Solvent Cement (use dauber) to end of conduit for the length of the socket to be attached.
- Push conduit firmly into fitting while rotating conduit slightly, about one-quarter turn to spread cement evenly.
- Allow joint to set approximately 10 minutes.

Carlon recommends the use of Carlon cement for proper solvent cement joints. Because this cement is prepared particularly for our product compounds and tolerances, we cannot guarantee joints assembled with cement materials supplied by other manufacturers. Regular-grade gray solvent cement will accommodate most application situations being of a general-purpose nature. In situations requiring an extremely fast-setting joint (low temperature or difficult installation conditions), Carlon All Weather Quick-Set Cement is recommended. Standard-grade clear cement is recommended for non-critical utility applications where gap filling and leak testing are not required.

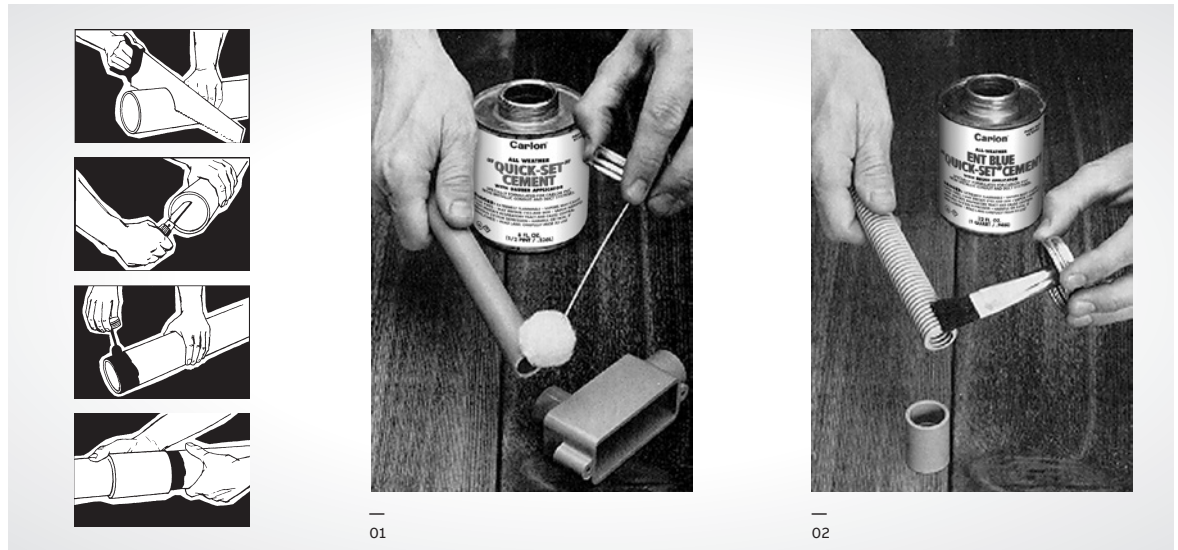

#### Average number of joints per can

Trade size (in.)	$\frac{1}{2}$ Pint 8 oz.	Pint 16 oz.	Quart 32 oz.	Gallon 128 oz.
$\frac{1}{2}$	140	275	550	2,200
$\frac{3}{4}$	90	180	360	1,440
1	70	140	280	1,120
$1\frac{1}{4}$	50	100	200	800
$1\frac{1}{2}$	37	75	150	600
2	20	40	80	320
$2\frac{1}{2}$	17	35	70	280
3	15	30	60	240
$3\frac{1}{2}$	13	27	54	216
4	12	25	50	200
5	9	19	38	150
6	6	12	24	95

Can: Average shelf life of all Carlon cement is 24 months (unopened cans stored below 80° F). All Carlon cements are specially formulated to be used with Carlon PVC products, and do not require primers when parts are clean of dirt and moisture. MSDS available at [www.carlon.com](http://www.carlon.com).

## Elbows, sweeps and accessories

Installation instructions - fittings and adapters for terminating non-metallic rigid conduit



Terminating non-metallic rigid conduit is quick and easy utilizing either of the methods indicated below. Terminations may be made in any electrical box or enclosure using standard size knockouts or drilled holes.

### Method 1. Permanent termination

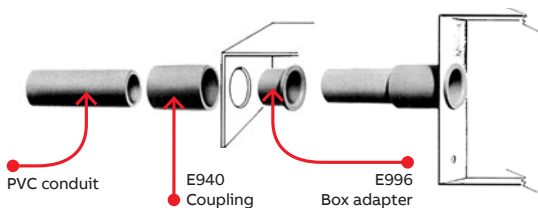

Apply solvent cement to shoulder and shank of box adapter and insert through knockout from inside the enclosure. Push coupling over the shank of the box adapter, tight against the enclosure wall. Rotate the coupling about one-half turn while installing, and hold in position for a few seconds to permit setting of solvent cement. The coupling is now ready for the conduit to be installed. Only the shoulder of the box adapter extends inside the enclosure.

### Method 2. Separable termination

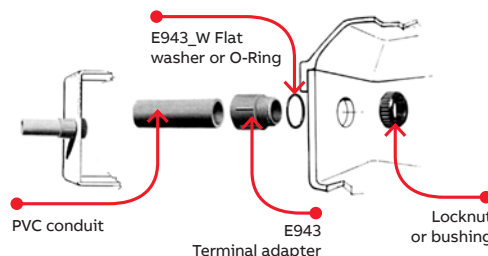

If a "wet location" as defined in Article 100 of the NEC® construction is required, place a flat washer or O-ring over the threads of the terminal adapter, securely against the shoulder. Insert the adapter threads through knockout and secure using either a standard locknut or threaded bushing. If watertight construction is not required, eliminate flat washer.

## PVC Conduit cutters

**Small cutter** - For fast, smooth field cuts of 1/2" through 1" non-metallic rigid conduit, Flex-Plus Blue ENT and Carflex liquidtight flexible non-metallic conduit.

	Cat. No.	Size (in.)	Std. Ctn.
	CC120B	8	10

## Elbows, sweeps and accessories

Conduit pulling lines for conductors or fiber optics



This rope is constructed of polyethylene over polyester, designed specifically for fiber optic pulling. The polyethylene jacket has a “slippery” feel that gives less drag in pulling through conduit.

White diamond braid rope

Cat. No.	Reel Lengths (ft.)	Diameter (in.)	Recommended Working Load (in.)	Approximate Avg. Tensile (lbs.)	Approximate Std. Wt. (lbs.)
SB14105	5,000	1/4	260	1,700	1,000



Pre-lubricated, woven polyester tape made from low-friction, high abrasion-resistant yarns, provides a low coefficient of friction. Tape is printed with sequential footage markings for accurate measurements.

Tape

Cat. No.	Size (in.)	Tensile strength (lbs.)	Reel lengths (ft.)
TL14203	1/2	1,130	3,000
TL14505	1/2	1,250	5,000
TL14510	1/2	1,250	10,000
TL38203	5/8	1,800	3,000
TL38265	5/8	1,800	6,500
TL38210	5/8	1,800	10,000



# Conduit bodies and fittings

## For use with Schedule 40 and 80 conduit

E945 series expansion fittings are designed to compensate for length changes due to temperature variations in exposed conduit runs.

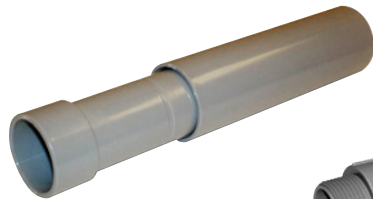

Coupling end



Male terminal adapter end

### Features and benefits:

- Exclusive molded-in mid-point indicator on the piston
- Exclusive 2" expansion fitting with an 8" travel distance
- Two-piece molded design with lubricated seals for easier movement for the life of the product
- Ridges on the fitting for easier installation (sizes 2"–6" only)
- Male terminal adapter end design (1/2"–2" NPT Threads and 2 1/2"–6" NPSC threads)
- Two O-rings to prevent leakage
- Can be installed vertically or horizontally



### Expansion fittings

Cat. No.	Male terminal adapter end Cat. No.	Size (in.)	Std. Ctn.	Travel length (in.)
E945D	E945DX	1/2	20	4
E945E	E945EX	3/4	15	4
E945F	E945FX	1	10	4
E945G	E945GX	1 1/4	5	4
E945H	E945HX	1 1/2	5	4
E945J	E945JX	2	15	8
E945K	E945KX	2 1/2	10	8
E945L	E945LX	3	10	8
E945M	E945MX	3 1/2	5	8
E945N	E945NX	4	5	8
E945P	E945PX	5	1	8
E945R	E945RX	6	1	8



Short expansion couplings - Expand to a maximum of 2"

Cat. No.	Size (in.)	Std. Ctn.
E955D	1/2	40
E955E	3/4	40
E955F	1	25
E955G	1 1/4	15
E955H	1 1/2	10
E955J	2	6

## Conduit bodies and fittings

For use with Schedule 40 and 80 conduit



Socket type for joining non-metallic conduit.

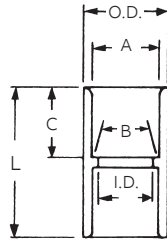

All socket fittings should be attached using Carlon solvent cement.

### Standard couplings



LR33856

Cat. No.	Size (in.)	Std. Ctn.	Typical (in.)		I.D. (in.)	O.D. (in.)	Typical (in.)	
			A	B			C	L
☛ E940D	1/2	150	.852	.836	.728	1 7/64	1 11/16	1 1/2
CE940DR-CTN	1/2	75	.852	.836	.728	1 7/64	1 11/16	1 1/2
☛ E940E	3/4	100	1.064	1.046	.840	1 5/16	3/4	1 5/8
CE940ER-CTN	3/4	45	1.064	1.046	.840	1 5/16	3/4	1 5/8
☛ E940F	1	50	1.330	1.310	1.210	1 5/8	1 5/16	2
CE940F-UPC	1	50	1.330	1.310	1.210	1 5/8	1 5/16	2
E940G	1 1/4	30	1.677	1.655	1.535	1 63/64	1	2 1/8
E940H	1 1/2	25	1.918	1.894	1.755	2 15/64	1 1/8	2 1/8
E940J	2	30	2.393	2.369	2.190	2 47/64	1 3/16	2 1/2
E940K	2 1/2	20	2.890	2.868	2.688	3 5/16	1 33/64	3 3/16
E940L	3	25	3.515	3.492	3.375	3 31/32	1 3/4	3 13/32
E940M	3 1/2	20	4.015	3.992	3.780	4 9/16	1 3/4	3 3/8
E940N	4	15	4.515	4.491	4.265	5 3/32	1 25/32	3 3/4
E940P	5	8	5.593	5.553	5.097	6 1/4	1 5/16	4 1/16
E940R	6	5	6.658	6.614	6.115	7 1/2	2 3/16	4 5/8

☛ Canada only.



### Special long-line couplings (with conduit stop)



E23018

Except where noted by ►

Cat. No.	Size (in.)	Std. Ctn.	Std. Wt. (lbs.)	Length (in.)
E941H	1 1/2	40	9	3.19
E941J	2	25	8	3.59
E941K	2 1/2	15	8	4.29
E941L	3	15	14	6.44
E941N	4	10	15	6.96
E941PF	5	4	12	9.63
► E941RF	6	5	21	11.75



### Fabricated expansion couplings



E23018

Cat. No.	Size (in.)	Std. Ctn.	Travel length (in.)
E945KXL	2 1/2	10	12

## Conduit bodies and fittings

For use with Schedule 40 and 80 conduit



Sleeve coupling (For repair work)  
No internal stop



E23018

Except where noted by ►

### Special long-line sleeve couplings

Cat. No.	Size (in.)	Std. Ctn.	Std. Wt. (lbs.)	Length (in.)
► E948H	1½	25	6	4
► E948J	2	25	5	3
► E948K	2½	25	16	6
► E948L	3	25	13	4
► E948N	4	10	8	6.5
► E948P	5	14	33	7
► E948R	6	6	16	6
► E948JR	2	15	8	6
► E948JS	2 (Sch. 40 split duct)	25	6	—
► E948KS7	2½ (Sch. 40 split duct)	25	19	7
► E948L12	3	1	1	12
► E948L6	3	15	15	6
► E948LS	3 (Sch. 40 split duct)	25	17	—
► E948N12	4	10	28	12
► E948N7	4	15	25	7
► E948NS	4 (Sch. 40 split duct)	10	15	—
► E948PS	5 (Sch. 40 split duct)	1	2	—
► E948R10	6	6	25	10
► E948R12	6	6	25	12
► E948RS	6 (Sch. 40 split duct)	1	2	—



### Special Schedule 40 swedge couplings

Cat. No.	Size (in.)	Std. Ctn.	Std. Wt. (lbs.)
► E442R	6	6	27
► E442T	8	2	17



### Schedule 40 risers

Cat. No.	Size (in.)	A (in.) (Length)	B (in.)	C (in.)	Thread size (in.)	Std. Ctn.	Std. Wt. (lbs.)
► E954HX	1½	80	1.567	.950	1½ NPT	1	3.8
► E954J	2	60	2.024	.825	2 NPT	1	3.7
► E954JX	2	80	2.024	.825	2 NPT	1	5
► E954K	2½	60	2.418	.812	2½ NPSC	1	6
► E954KX	2½	80	2.418	.812	2½ NPSC	1	8.4
► E954L	3	60	3.616	.798	3 NPSC	1	8.7
► E954LX	3	80	3.616	.798	3 NPSC	1	11

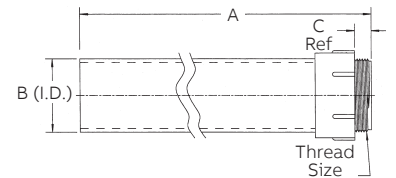

## Conduit bodies and fittings

For use with Schedule 40 and 80 conduit



For adapting non-metallic conduits to threaded fittings, metallic systems. Female threads on one end, socket end on other.

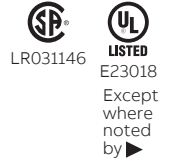
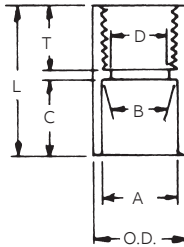

### Female adapters

Cat. No.	Size (in.)	Std. Ctn.	Typical (in.)		Min. D (in.)	Max. O.D. (in.)	Typical (in.)		
			A	B			C	S	L
E942D	1/2	150	.852	.836	.620	1 7/64	11/16	3/4	1 9/16
E942E	3/4	100	1.064	1.046	.822	1 5/16	13/16	3/4	1 5/8
E942F	1	50	1.330	1.310	1.046	1 5/8	15/16	7/8	1 15/16
E942G	1 1/4	30	1.677	1.655	1.377	1 63/64	1	7/8	2
E942H	1 1/2	25	1.918	1.894	1.607	2 5/32	1 1/8	7/8	2 7/32
E942J	2	30	2.393	2.369	2.064	2 47/64	1 3/16	1	2 5/16
E942K	2 1/2	20	2.890	2.868	2.450	3 11/32	1 5/8	1 1/8	2 15/16
E942L	3	25	3.515	3.492	3.000	3 31/32	1 3/4	1 1/8	3 1/16
E942M	3 1/2	20	4.015	3.992	3.500	4 1/2	1 7/8	1 1/8	3 1/4
E942N	4	15	4.515	4.491	4.000	5 1/64	1 3/4	1 1/16	3 13/64
▶ E942NX9*	4	15							(Call for information)
E942P	5	8	5.593	5.553	5.047	6 1/4	1 15/16	1 1/16	3 3/16
E942R	6	6	6.658	6.614	6.055	7 1/4	2 1/8	1 1/16	3 3/8
▶ E942RX*	6	6							(Call for information)

\* Long-Line Adapter



For adapting non-metallic conduits to boxes, threaded fittings, metallic systems. Male threads on one end, socket end on other.

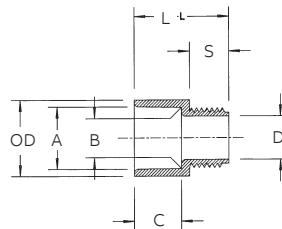

### Male terminal adapters

Cat. No.	Size (in.)	Std. Ctn.	Typical (in.)		Min. D (in.)	Max. O.D. (in.)	Typical (in.)		
			A	B			C	S	L
E943D	1/2	150	.852	.836	.594	1.042	.652	.545	1.310
E943E	3/4	125	1.064	1.046	.793	1.290	.809	.553	1.470
E943F	1	50	1.330	1.310	1.025	1.580	.965	.812	1.902
E943G	1 1/4	50	1.677	1.655	1.345	1.973	1.208	.816	1.986
E943H	1 1/2	25	1.918	1.894	1.574	2.188	1.155	.802	2.105
E943J	2	50	2.393	2.369	1.998	2.713	1.145	.825	2.093
E943K	2 1/2	25	2.890	2.868	2.400	3.290	1.490	.812	2.480
E943L	3	45	3.515	3.492	2.989	3.965	1.643	.797	2.660
E943M	3 1/2	30	4.015	3.992	3.405	4.515	1.720	.802	2.740
E943N	4	20	4.515	4.491	3.895	5.065	1.788	.733	2.830
E943P	5	5	5.593	5.553	4.900	6.104	1.935	.990	3.200
E943R	6	10	6.658	6.614	5.900	7.288	2.128	.985	3.410

## Conduit bodies and fittings

For use with Schedule 40 and 80 conduit



Adapts non-metallic conduit to all electrical enclosures by inserting adapter through knockout and cementing into Carlon couplings.

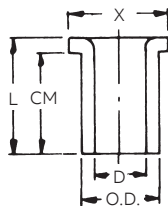

### Box adapters for enclosures

Cat. No.	Size (in.)	Std. Ctn.	Min. D (in.)	OD (in.) Typical	Max. X (in.)	CM (in.) Typical	L (in.) Typical
E996D	1/2	100	.662	0.840	17/64	23/32	27/32
E996E	3/4	100	.824	1.050	121/64	25/32	29/32
E996F	1	100	1.049	1.315	15/8	61/64	13/32
E996G	1 1/4	50	1.380	1.660	131/32	11/16	1 1/4
E996H	1 1/2	50	1.610	1.900	213/64	13/16	1 3/8
E996J	2	25	2.067	2.375	229/32	1 1/4	1 7/16
E996K	2 1/2	15	2.469	2.875	37/16	1 7/8	1 15/16
E996L	3	20	3.068	3.500	4 1/8	2	2 1/16
E996N	4	10	4.026	4.500	5 1/8	2 1/2	2 1/4



### Threaded adapters

Cat. No.	Size (in.)	Std. Ctn.
E9842D <sup>1</sup>	1/2	25
E9842E <sup>2</sup>	3/4	25

<sup>1</sup> Fits 3/4" sockets

<sup>2</sup> Fits 1" sockets



### Reducer plugs

Cat. No.	Size (in.)	Std. Ctn.	Std. Wt. (lbs.)
▶ E971C	3/4 x 1/2	100	2
▶ E971D	1 x 3/4	100	3



LISTED  
E23018  
Except where noted by ▶



### Plugs (Polyethylene)

Cat. No.	Size (in.)	Std. Ctn.	Std. Wt. (lbs.)
▶ P258H	1 1/2	50	2
▶ P258K	2 1/2	25	1.5



LISTED  
E23018  
Except where noted by ▶



### Plugs with pull tabs (Polyethylene)

Cat. No.	Size (in.)	Std. Ctn.	Std. Wt. (lbs.)
▶ P258JT	2	60	3
▶ P258LT	3	30	3
▶ P258NT	4	48	8
▶ P258PT	5	30	6
▶ P258RT	6	30	9



LISTED  
E23018  
Except where noted by ▶

## Conduit bodies and fittings

For use with Schedule 40 and 80 conduit



For connecting different sizes of conduit. Bell x Spigot.

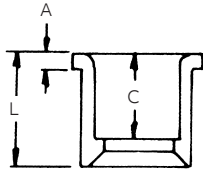

**UL**  
LISTED  
E23018  
Except where noted by ▶

### Reducer bushings

Cat. No.	Size (in.)	Std. Ctn.	L (in.) Typical	A (in.) Typical	C (in.) Typical
E950ED	3/4 x 1/2	100	1 <sup>5</sup> / <sub>32</sub>	1 <sup>3</sup> / <sub>64</sub>	1 <sup>1</sup> / <sub>32</sub>
E950FD-CAR	1 x 1/2	25	1 <sup>11</sup> / <sub>32</sub>	3/16	5 <sup>7</sup> / <sub>64</sub>
E950FE	1 x 3/4	100	1 <sup>11</sup> / <sub>32</sub>	3/16	1 <sup>1</sup> / <sub>64</sub>
E950GE-CAR	1 <sup>1</sup> / <sub>4</sub> x 3/4	10	1 <sup>15</sup> / <sub>32</sub>	3/16	1 <sup>1</sup> / <sub>64</sub>
E950GF	1 <sup>1</sup> / <sub>4</sub> x 1	50	1 <sup>15</sup> / <sub>32</sub>	3/16	1 <sup>9</sup> / <sub>64</sub>
E950HF-CAR	1 <sup>1</sup> / <sub>2</sub> x 1	10	1 <sup>19</sup> / <sub>32</sub>	3/16	1 <sup>9</sup> / <sub>64</sub>
E950HG-CAR	1 <sup>1</sup> / <sub>2</sub> x 1 <sup>1</sup> / <sub>4</sub>	10	1 <sup>19</sup> / <sub>32</sub>	3/16	1 <sup>17</sup> / <sub>64</sub>
E950JG-CAR	2 x 1 <sup>1</sup> / <sub>4</sub>	10	1 <sup>3</sup> / <sub>4</sub>	7/32	1 <sup>17</sup> / <sub>64</sub>
E950JH-CAR	2 x 1 <sup>1</sup> / <sub>2</sub>	10	1 <sup>3</sup> / <sub>4</sub>	7/32	1 <sup>25</sup> / <sub>64</sub>
E950KJ-CAR	2 <sup>1</sup> / <sub>2</sub> x 2	10	2 <sup>5</sup> / <sub>32</sub>	3/8	1 <sup>27</sup> / <sub>64</sub>
E950LJ-CAR	3 x 2	10	2 <sup>1</sup> / <sub>8</sub>	1/4	1 <sup>7</sup> / <sub>8</sub>
▶ E950LK	3 x 2 <sup>1</sup> / <sub>2</sub>	25	1 <sup>15</sup> / <sub>16</sub>	1/4	1 <sup>11</sup> / <sub>16</sub>
E950NL	4 x 3	25	2 <sup>3</sup> / <sub>4</sub>	5/16	1 <sup>15</sup> / <sub>16</sub>



### Fabricated reducers

**UL**  
LISTED  
E23018  
Except where noted by ▶

Cat. No.	Size (in.)	Std. Ctn.	Std. Wt. (lbs.)
<b>Male x male</b>			
▶ E952JH	1 <sup>1</sup> / <sub>2</sub> x 2	48	20
▶ E952KJ	2 <sup>1</sup> / <sub>2</sub> x 2	48	26
▶ E952LJ	3 x 2	36	21
▶ E952LK	3 x 2 <sup>1</sup> / <sub>2</sub>	36	32
▶ E952NL	4 x 3	15	21
▶ E952NM	4 x 3 <sup>1</sup> / <sub>2</sub>	15	25
▶ E952PN	5 x 4	12	27
▶ E952RP	6 x 5	10	31
<b>Male x female</b>			
▶ E952NJF	4 x 2	15	16
▶ E952RNF	6 x 4	10	28

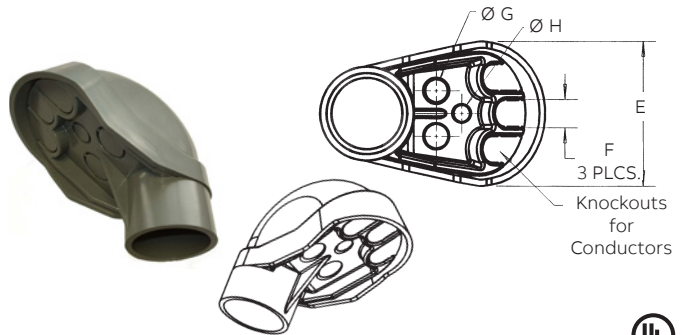

### Service entrance caps (Vertical applications only)

**UL**  
LISTED  
E13938

Cat. No.	Size (in.)	Std. Ctn.	Dimensions (in.)			
			E	F	G	H
E998D	1/2	5	1.76	.45	.45	-
E998E	3/4	20	1.76	.45	.45	-
E998E-CAR	3/4	5	1.76	.45	.45	-
E998F	1	15	2.26	.59	.58	-
E998F-CAR	1	5	2.26	.59	.58	-
E998G-CAR	1 <sup>1</sup> / <sub>4</sub>	5	3.52	.74	.71	.50
E998H-CAR	1 <sup>1</sup> / <sub>2</sub>	5	3.52	.74	.71	.50
E998J-CAR	2	5	4.26	.83	.78	.56
E998K-UPC	2 <sup>1</sup> / <sub>2</sub>	2	7.47	1.70	1.31	1.00
E998L	3	2	7.47	1.70	1.31	1.00
E998N	4	2	10.45	2.25	1.88	1.31

**UL**  
LISTED  
E23018  
Except where noted by ▶

### End caps

Cat. No.	Size (in.)	Std. Ctn.	Std. Wt. (lbs.)
▶ E958D	1/2	100	3
▶ E958E	3/4	100	4
▶ E958F	1	75	5
▶ E958G	1 <sup>1</sup> / <sub>4</sub>	40	4
▶ E958H	1 <sup>1</sup> / <sub>2</sub>	30	4
▶ E958J	2	25	5
▶ E958K	2 <sup>1</sup> / <sub>2</sub>	10	4
▶ E958L	3	10	5
▶ E958N	4	5	17
▶ E958P	5	5	11
▶ E958R	6	5	13

### PVC riser caps

Cat. No.	Size (in.)	Std. Ctn.	Std. Wt. (lbs.)
▶ E935J	2	25	3
▶ E935L	3	25	5
▶ E935N	4	25	7
▶ E935P	5	25	35
▶ E935R	6	10	7

## Conduit bodies and fittings

For use with Schedule 40 and 80 conduit

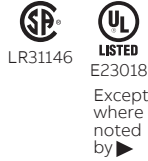

### Meter offset

	Cat. No.	Size (in.)	Std. Ctn.	Offset (in.)	A (in.)
	▶ E995G	1 1/4	15	.758	4.230
	▶ E995J	2	8	.684	4.270

### Offset

	Cat. No.	Size (in.)	Std. Ctn.	Offset (in.)	Std. Wt. (lbs.)
	▶ E994D	1/2	.250	25	3
	▶ E994E	3/4	.250	25	3
	▶ E994F	1	.500	50	12

### End bells

	Cat. No.	Size (in.)	Std. Ctn.	Std. Wt. (lbs.)
	E997F	1	50	2.6
	E997G	1 1/4	35	2.5
	E997H	1 1/2	30	2.5
	E997J	2	40	5.0
	E997K	2 1/2	30	2
	E997L	3	50	10
	E997M	3 1/2	40	11
	E997N	4	30	16
	▶ E997P	5	15	8
	▶ E997R	6	10	7
	▶ E997T	8	3	15

### End bells - Schedule 40 fabricated

	Cat. No.	Size (in.)	Std. Ctn.	Std. Wt. (lbs.)
	▶ E949J5	2 x 5	50	10
	▶ E949J6	2 x 6	25	12
	▶ E949JN	2 x 4	25	7
	▶ E949JX	2 x 8	12	7
	▶ E949LR	3 x 6	20	21
	▶ E949N5	4 x 5	20	2
	▶ E949NR	4 x 6	15	21
	▶ E949R5	6 x 5	12	27
▶ E949RX	6 x 8	6	17	

Where a waterproof termination is required into any enclosure (metallic or non-metallic), install the neoprene washer over the threads of a terminal adapter before inserting into the enclosure. Use a standard locknut or threaded bushing to secure the assembly.

### Flat sealing washers

	Cat. No.	Size (in.)	Std. Ctn.
	▶ E943DW	1/2	125
	▶ E943EW	3/4	125
	▶ E943FW	1	100
	▶ E943GW	1 1/4	50
	▶ E943HW	1 1/2	50
	▶ E943JW	2	25

### PVC locknuts

	Cat. No.	Size (in.)	Std. Ctn.
	▶ LT9LD	1/2	1200
	▶ LT9LE	3/4	700
	▶ LT9LF	1	600

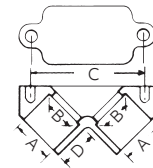

### Access pull elbows

Cat. No.	Size (in.)	Std. Ctn.	A (in.) Typical	B (in.) Typical	C (in.) Typical	D (in.) Typical
E990D <sup>†</sup>	1/2	75	.852	.836	2.187	.718
E990E <sup>†</sup>	3/4	50	1.064	1.046	2.531	.718

<sup>†</sup> Gasket included.



## Conduit bodies and fittings

For use with Schedule 40 and 80 conduit

HOLFORM™ non-metallic concrete sleeve forms are the easy way to form holes in concrete. They install in seconds with nails, screws or staples and are easily removed. Concrete will not adhere to them. Sleeves are adjustable to any slab thickness.

Four knock-out type socket openings, 90° spacing. Available with 1/2" or 3/4" socket outlets. Includes cover and gasket.

**Note:** Not fixture rated.

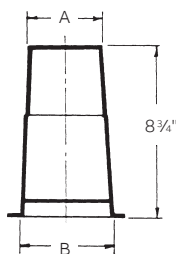

HOLFORM Concrete sleeves

Cat. No.	Min. O.D. A (in.)	B. (in.)	Std. Ctn.	Std. Wt. (lbs.)
†▶ E92CSH	1½	1¾	20	3
†▶ E92CSJ	2	2 <sup>13</sup> / <sub>32</sub>	25	6
†▶ E92CSL	3	3 <sup>13</sup> / <sub>32</sub>	25	8
†▶ E92CSN	4	4 <sup>13</sup> / <sub>32</sub>	18	8
†▶ E92CSP	5	5 <sup>13</sup> / <sub>32</sub>	15	8
†▶ E92CSR	6	6 <sup>13</sup> / <sub>32</sub>	12	8

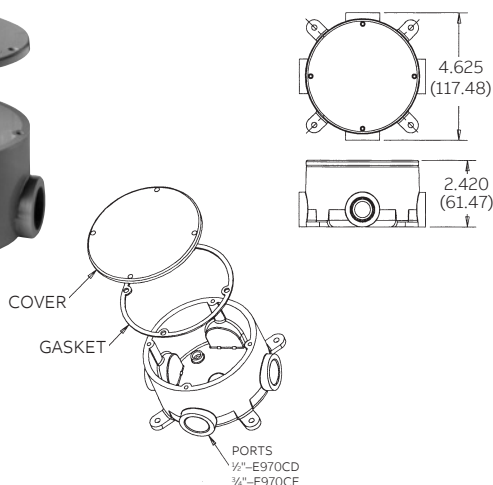

Conduit bodies Type X with cover

Cat. No.	Size (in.)	Vol. (cu.in.)	Std. Ctn.
▶ E970CD	½	15.16	15
▶ E970CE	¾	15.16	15

Supplied with four stainless steel cover screws. Diameter 4/8", thickness 1/4". Not designed for use with wiring devices or light fixtures.

Feature unthreaded hubs and textured lids with foam-in-place gaskets.

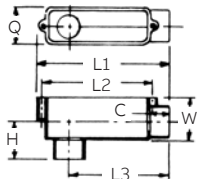

Conduit bodies - Type LB

Cat. No.	Size (in.)	Std. Ctn.	Dimensions (in.)							Vol. Cu. (in.)
			Typical max.		Typical		Max.	Max.	Max.	
			C	L1	L2	L3	H	Q	W	
E986D	½	25	1 <sup>1</sup> / <sub>16</sub>	4 <sup>5</sup> / <sub>16</sub>	3 <sup>7</sup> / <sub>32</sub>	3 <sup>1</sup> / <sub>16</sub>	1 <sup>5</sup> / <sub>16</sub>	1 <sup>11</sup> / <sub>32</sub>	1 <sup>1</sup> / <sub>2</sub>	4.0
E986E	¾	15	2 <sup>9</sup> / <sub>32</sub>	6 <sup>9</sup> / <sub>32</sub>	5 <sup>9</sup> / <sub>32</sub>	4 <sup>25</sup> / <sub>32</sub>	1 <sup>25</sup> / <sub>32</sub>	1 <sup>3</sup> / <sub>4</sub>	2 <sup>1</sup> / <sub>32</sub>	12.0
E986F	1	10	2 <sup>9</sup> / <sub>32</sub>	6 <sup>9</sup> / <sub>32</sub>	5 <sup>9</sup> / <sub>32</sub>	4 <sup>25</sup> / <sub>32</sub>	1 <sup>25</sup> / <sub>32</sub>	1 <sup>3</sup> / <sub>4</sub>	2 <sup>1</sup> / <sub>32</sub>	12.0
E986G	1¼	10	1 <sup>3</sup> / <sub>32</sub>	7 <sup>31</sup> / <sub>32</sub>	6 <sup>13</sup> / <sub>32</sub>	6	2 <sup>5</sup> / <sub>16</sub>	2 <sup>1</sup> / <sub>2</sub>	2 <sup>3</sup> / <sub>4</sub>	32.0
E986H	1½	10	1 <sup>3</sup> / <sub>32</sub>	7 <sup>31</sup> / <sub>32</sub>	6 <sup>13</sup> / <sub>32</sub>	6	2 <sup>5</sup> / <sub>16</sub>	2 <sup>1</sup> / <sub>2</sub>	2 <sup>3</sup> / <sub>4</sub>	32.0
E986J	2	10	1 <sup>5</sup> / <sub>32</sub>	9 <sup>31</sup> / <sub>32</sub>	8 <sup>13</sup> / <sub>32</sub>	7 <sup>1</sup> / <sub>4</sub>	2 <sup>9</sup> / <sub>16</sub>	3 <sup>5</sup> / <sub>32</sub>	3 <sup>15</sup> / <sub>32</sub>	63.0
▶ E986K	2½	4	1 <sup>5</sup> / <sub>8</sub>	14 <sup>7</sup> / <sub>8</sub>	13 <sup>1</sup> / <sub>4</sub>	11 <sup>31</sup> / <sub>32</sub>	3 <sup>3</sup> / <sub>4</sub>	4 <sup>11</sup> / <sub>32</sub>	4 <sup>5</sup> / <sub>8</sub>	210
▶ E986L	3	4	1 <sup>5</sup> / <sub>8</sub>	14 <sup>7</sup> / <sub>8</sub>	13 <sup>1</sup> / <sub>4</sub>	11 <sup>31</sup> / <sub>32</sub>	3 <sup>3</sup> / <sub>4</sub>	4 <sup>11</sup> / <sub>32</sub>	4 <sup>5</sup> / <sub>8</sub>	210
▶ E986M	3½	4	1 <sup>25</sup> / <sub>32</sub>	17 <sup>23</sup> / <sub>32</sub>	15 <sup>7</sup> / <sub>8</sub>	14 <sup>17</sup> / <sub>64</sub>	4 <sup>7</sup> / <sub>16</sub>	5 <sup>11</sup> / <sub>32</sub>	5 <sup>21</sup> / <sub>32</sub>	390
▶ E986N	4	4	1 <sup>25</sup> / <sub>32</sub>	17 <sup>23</sup> / <sub>32</sub>	15 <sup>7</sup> / <sub>8</sub>	14 <sup>17</sup> / <sub>64</sub>	4 <sup>7</sup> / <sub>16</sub>	5 <sup>11</sup> / <sub>32</sub>	5 <sup>21</sup> / <sub>32</sub>	390

**Note:** Covers are not sold as separate item.

## Conduit bodies and fittings

For use with Schedule 40 and 80 conduit

Feature unthreaded hubs and textured lids with foam-in-place gaskets.

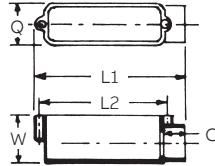

Conduit bodies - Type E



Cat. No.	Size (in.)	Std. Ctn.	Dimensions (in.)					Vol. Cu. (in.)
			C	Typical max. L1	Typical L2	Max. Q	Max. W	
E988D	1/2	25	1/16	4 <sup>5</sup> / <sub>16</sub>	3 <sup>1</sup> / <sub>2</sub>	1 <sup>11</sup> / <sub>32</sub>	1 <sup>1</sup> / <sub>2</sub>	4.0
E988E	3/4	20	2 <sup>9</sup> / <sub>32</sub>	6 <sup>11</sup> / <sub>32</sub>	5 <sup>9</sup> / <sub>32</sub>	1 <sup>3</sup> / <sub>4</sub>	2 <sup>1</sup> / <sub>32</sub>	12.0
E988F	1	10	2 <sup>9</sup> / <sub>32</sub>	6 <sup>11</sup> / <sub>32</sub>	5 <sup>9</sup> / <sub>32</sub>	1 <sup>3</sup> / <sub>4</sub>	2 <sup>1</sup> / <sub>32</sub>	12.0
E988G	1 <sup>1</sup> / <sub>4</sub>	10	1 <sup>3</sup> / <sub>32</sub>	8	6 <sup>13</sup> / <sub>32</sub>	2 <sup>1</sup> / <sub>2</sub>	2 <sup>3</sup> / <sub>4</sub>	32.0
E988H	1 <sup>1</sup> / <sub>2</sub>	10	1 <sup>3</sup> / <sub>32</sub>	8	6 <sup>13</sup> / <sub>32</sub>	2 <sup>1</sup> / <sub>2</sub>	2 <sup>3</sup> / <sub>4</sub>	32.0
E988J	2	5	1 <sup>5</sup> / <sub>32</sub>	9 <sup>15</sup> / <sub>32</sub>	8 <sup>13</sup> / <sub>32</sub>	3 <sup>5</sup> / <sub>32</sub>	31 <sup>5</sup> / <sub>32</sub>	63.0

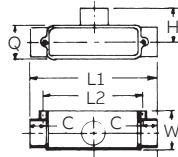

Conduit bodies - Type C

Cat. No.	Size (in.)	Std. Ctn.	Dimensions (in.)					Vol. Cu. (in.)
			C	Typical max. L1	Typical L2	Max. Q	Max. W	
E987D	1/2	25	1 <sup>1</sup> / <sub>16</sub>	4 <sup>11</sup> / <sub>16</sub>	3 <sup>1</sup> / <sub>2</sub>	1 <sup>11</sup> / <sub>32</sub>	1 <sup>1</sup> / <sub>2</sub>	4.0
E987E-CAR	3/4	10	2 <sup>9</sup> / <sub>32</sub>	6 <sup>7</sup> / <sub>8</sub>	5 <sup>32</sup> / <sub>64</sub>	1 <sup>3</sup> / <sub>4</sub>	2 <sup>1</sup> / <sub>32</sub>	12.0
E987F-CAR	1	10	2 <sup>9</sup> / <sub>32</sub>	6 <sup>7</sup> / <sub>8</sub>	5 <sup>9</sup> / <sub>32</sub>	1 <sup>3</sup> / <sub>4</sub>	2 <sup>1</sup> / <sub>32</sub>	12.0
E987G	1 <sup>1</sup> / <sub>4</sub>	10	1 <sup>3</sup> / <sub>32</sub>	8 <sup>21</sup> / <sub>32</sub>	6 <sup>13</sup> / <sub>32</sub>	2 <sup>1</sup> / <sub>2</sub>	2 <sup>3</sup> / <sub>4</sub>	32.0
E987H	1 <sup>1</sup> / <sub>2</sub>	10	1 <sup>3</sup> / <sub>32</sub>	8 <sup>21</sup> / <sub>32</sub>	6 <sup>13</sup> / <sub>32</sub>	2 <sup>1</sup> / <sub>2</sub>	2 <sup>3</sup> / <sub>4</sub>	32.0
E987J	2	15	1 <sup>5</sup> / <sub>32</sub>	10 <sup>5</sup> / <sub>16</sub>	8 <sup>13</sup> / <sub>32</sub>	3 <sup>5</sup> / <sub>32</sub>	31 <sup>15</sup> / <sub>32</sub>	63.0

## Conduit bodies and fittings

For use with Schedule 40 and 80 conduit

Feature unthreaded hubs and textured lids with foam-in-place gaskets.

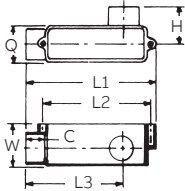

Conduit bodies - Type LR

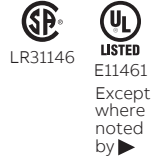

Cat. No.	Size (in.)	Std. Ctn.	Typical max.		Typical		Max. H	Max. Q	Max. W	Vol. Cu. (in.)
			C	L1	L2	L3				
E985D-CAR	1/2	10	11/16	4 <sup>5</sup> / <sub>16</sub>	3 <sup>7</sup> / <sub>32</sub>	3 <sup>1</sup> / <sub>16</sub>	1 <sup>5</sup> / <sub>16</sub>	1 <sup>11</sup> / <sub>32</sub>	1 <sup>1</sup> / <sub>2</sub>	4.0
E985E-CAR	3/4	10	2 <sup>9</sup> / <sub>32</sub>	6 <sup>9</sup> / <sub>32</sub>	5 <sup>9</sup> / <sub>32</sub>	4 <sup>25</sup> / <sub>32</sub>	1 <sup>25</sup> / <sub>32</sub>	1 <sup>3</sup> / <sub>4</sub>	2 <sup>1</sup> / <sub>32</sub>	12.0
E985F	1	10	2 <sup>9</sup> / <sub>32</sub>	6 <sup>9</sup> / <sub>32</sub>	5 <sup>9</sup> / <sub>32</sub>	4 <sup>25</sup> / <sub>32</sub>	1 <sup>25</sup> / <sub>32</sub>	1 <sup>3</sup> / <sub>4</sub>	2 <sup>1</sup> / <sub>32</sub>	12.0
E985G	1 <sup>1</sup> / <sub>4</sub>	10	1 <sup>3</sup> / <sub>32</sub>	7 <sup>31</sup> / <sub>32</sub>	6 <sup>13</sup> / <sub>32</sub>	6	2 <sup>5</sup> / <sub>16</sub>	2 <sup>1</sup> / <sub>2</sub>	2 <sup>3</sup> / <sub>4</sub>	32.0
E985H-CAR	1 <sup>1</sup> / <sub>2</sub>	5	1 <sup>3</sup> / <sub>32</sub>	7 <sup>31</sup> / <sub>32</sub>	6 <sup>13</sup> / <sub>32</sub>	6	2 <sup>5</sup> / <sub>16</sub>	2 <sup>1</sup> / <sub>2</sub>	2 <sup>3</sup> / <sub>4</sub>	32.0
E985J	2	10	1 <sup>5</sup> / <sub>32</sub>	9 <sup>31</sup> / <sub>32</sub>	8 <sup>13</sup> / <sub>32</sub>	7 <sup>1</sup> / <sub>4</sub>	2 <sup>9</sup> / <sub>16</sub>	3 <sup>5</sup> / <sub>32</sub>	3 <sup>15</sup> / <sub>32</sub>	63.0

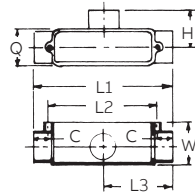

Conduit bodies - Type T

Cat. No.	Size (in.)	Std. Ctn.	Typical max.		Typical		Max. H	Max. Q	Max. W	Vol. Cu. (in.)
			C	L1	L2	L3				
E983D-CAR	1/2	10	11/16	4 <sup>11</sup> / <sub>16</sub>	3 <sup>7</sup> / <sub>32</sub>	2 <sup>11</sup> / <sub>32</sub>	1 <sup>5</sup> / <sub>16</sub>	1 <sup>11</sup> / <sub>32</sub>	1 <sup>1</sup> / <sub>2</sub>	4.0
E983E	3/4	15	2 <sup>9</sup> / <sub>32</sub>	6 <sup>7</sup> / <sub>8</sub>	5 <sup>9</sup> / <sub>32</sub>	4 <sup>7</sup> / <sub>16</sub>	1 <sup>25</sup> / <sub>32</sub>	1 <sup>3</sup> / <sub>4</sub>	2 <sup>1</sup> / <sub>32</sub>	12.0
E983F	1	20	2 <sup>9</sup> / <sub>32</sub>	6 <sup>7</sup> / <sub>8</sub>	5 <sup>9</sup> / <sub>32</sub>	3 <sup>7</sup> / <sub>16</sub>	1 <sup>25</sup> / <sub>32</sub>	1 <sup>3</sup> / <sub>4</sub>	2 <sup>1</sup> / <sub>32</sub>	12.0
E983G	1 <sup>1</sup> / <sub>4</sub>	10	1 <sup>3</sup> / <sub>32</sub>	8 <sup>21</sup> / <sub>32</sub>	6 <sup>13</sup> / <sub>32</sub>	4 <sup>21</sup> / <sub>64</sub>	2 <sup>5</sup> / <sub>16</sub>	2 <sup>1</sup> / <sub>2</sub>	2 <sup>3</sup> / <sub>4</sub>	32.0
E983H	1 <sup>1</sup> / <sub>2</sub>	10	1 <sup>3</sup> / <sub>32</sub>	8 <sup>21</sup> / <sub>32</sub>	6 <sup>13</sup> / <sub>32</sub>	4 <sup>21</sup> / <sub>64</sub>	2 <sup>5</sup> / <sub>16</sub>	2 <sup>1</sup> / <sub>2</sub>	2 <sup>3</sup> / <sub>4</sub>	32.0
E983J	2	10	1 <sup>5</sup> / <sub>32</sub>	10 <sup>5</sup> / <sub>16</sub>	8 <sup>13</sup> / <sub>32</sub>	5 <sup>5</sup> / <sub>32</sub>	2 <sup>9</sup> / <sub>16</sub>	3 <sup>5</sup> / <sub>32</sub>	3 <sup>15</sup> / <sub>16</sub>	63.0

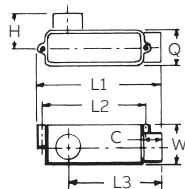

Conduit bodies - Type LL

Cat. No.	Size (in.)	Std. Ctn.	Typical max.		Typical		Max. H	Max. Q	Max. W	Vol. Cu. (in.)
			C	L1	L2	L3				
E984D-CAR	1/2	10	11/16	4 <sup>5</sup> / <sub>16</sub>	3 <sup>7</sup> / <sub>32</sub>	2 <sup>1</sup> / <sub>16</sub>	1 <sup>5</sup> / <sub>16</sub>	1 <sup>11</sup> / <sub>32</sub>	1 <sup>1</sup> / <sub>2</sub>	4.0
E984E	3/4	20	2 <sup>9</sup> / <sub>32</sub>	6 <sup>9</sup> / <sub>32</sub>	5 <sup>9</sup> / <sub>32</sub>	4 <sup>25</sup> / <sub>32</sub>	1 <sup>25</sup> / <sub>32</sub>	1 <sup>3</sup> / <sub>4</sub>	2 <sup>1</sup> / <sub>32</sub>	12.0
E984F-CAR	1	10	2 <sup>9</sup> / <sub>32</sub>	6 <sup>9</sup> / <sub>32</sub>	5 <sup>9</sup> / <sub>32</sub>	4 <sup>25</sup> / <sub>32</sub>	1 <sup>25</sup> / <sub>32</sub>	1 <sup>3</sup> / <sub>4</sub>	2 <sup>1</sup> / <sub>32</sub>	12.0
E984G-CAR	1 <sup>1</sup> / <sub>4</sub>	5	1 <sup>3</sup> / <sub>32</sub>	7 <sup>31</sup> / <sub>32</sub>	6 <sup>13</sup> / <sub>32</sub>	6	2 <sup>5</sup> / <sub>16</sub>	2 <sup>1</sup> / <sub>2</sub>	2 <sup>3</sup> / <sub>4</sub>	32.0
E984H	1 <sup>1</sup> / <sub>2</sub>	10	1 <sup>3</sup> / <sub>32</sub>	7 <sup>31</sup> / <sub>32</sub>	6 <sup>13</sup> / <sub>32</sub>	6	2 <sup>5</sup> / <sub>16</sub>	2 <sup>1</sup> / <sub>2</sub>	2 <sup>3</sup> / <sub>4</sub>	32.0
E984J	2	10	1 <sup>5</sup> / <sub>32</sub>	9 <sup>9</sup> / <sub>32</sub>	8 <sup>13</sup> / <sub>32</sub>	7 <sup>1</sup> / <sub>4</sub>	2 <sup>9</sup> / <sub>16</sub>	3 <sup>5</sup> / <sub>32</sub>	3 <sup>15</sup> / <sub>16</sub>	63.0

# Switch and junction boxes

## Molded non-metallic junction boxes – 6P rated

Non-metallic junction boxes are UL Listed with a NEMA 6P rating per Section 314.29, Exception of the National Electrical Code® and CSA Certified per Section 12 of the Canadian Electrical Code.

Manufactured from PVC or PPO thermoplastic molding compound and featuring foam in-place gasketed lids attached with stainless steel screws, these rugged enclosures offer all the corrosion resistance and physical properties you need for direct-burial applications.

Type 6P enclosures are intended for indoor or outdoor use, primarily to provide a degree of protection against contact with enclosed equipment, falling dirt, hose-directed water, entry of water during prolonged submersion at a limited depth and external ice formation.



Molded non-metallic junction boxes – 6P rated

### Features and benefits:

- All Carlon junction boxes are UL Listed/CSA Certified and maintain a minimum of a NEMA Type 4/4X Rating
- Part numbers with an asterisk (\*) are UL Listed and maintain a NEMA Type 6P Rating and Type 4/4X Rating
- Covers are not sold as separate item
- Temperature range: -250° F to 125° F
- UL94V-2 flammability rating

**Note:** Not rated for pedestrian traffic.

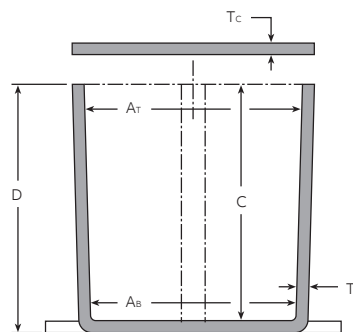
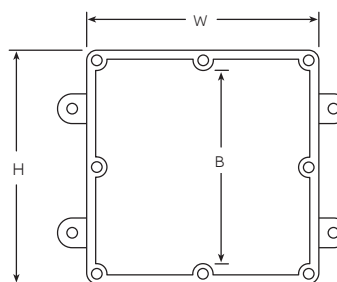

Cat. No.	Size H x W x D (in.)	Std. Ctn.	Dimensions (in.)					Material			Std. Wt.
			Min. AT	Min. AB	Min. B	Min. C	T <sub>B</sub>	T <sub>C</sub>	PVC	Thermo- plastic	
E989NNJ*	4 x 4 x 2	10	3 <sup>11</sup> / <sub>16</sub>	3 <sup>5</sup> / <sub>8</sub>	N/A	2	0.160	0.155	X		3
E987N*	4 x 4 x 4	10	3 <sup>11</sup> / <sub>16</sub>	3 <sup>1</sup> / <sub>2</sub>	N/A	4	0.160	0.155	X		4
▶ E989NNR*	4 x 4 x 6	10	3 <sup>11</sup> / <sub>16</sub>	3 <sup>3</sup> / <sub>8</sub>	N/A	6	0.160	0.200	X		5
E989PPJ*	5 x 5 x 2	10	4 <sup>11</sup> / <sub>16</sub>	4 <sup>1</sup> / <sub>2</sub>	N/A	2	0.110	0.150		X	3
E987R-CAR*	6 x 6 x 4	2	6	5 <sup>5</sup> / <sub>8</sub>	N/A	4	0.190	0.190		X	3
E989RRR-UPC*	6 x 6 x 6	8	5 <sup>5</sup> / <sub>8</sub>	5 <sup>3</sup> / <sub>8</sub>	N/A	6	0.160	0.150		X	14
E989N-CAR	8 x 8 x 4	1	8	8	N/A	4	0.185	0.190		X	2
E989SSX-UPC	8 x 8 x 7	2	7 <sup>21</sup> / <sub>32</sub>	7 <sup>5</sup> / <sub>16</sub>	N/A	7	0.160	0.150		X	6
E989UUN	12 x 12 x 4	3	11 <sup>5</sup> / <sub>8</sub>	11 <sup>1</sup> / <sub>2</sub>	11 <sup>1</sup> / <sub>8</sub>	4	0.160	0.150		X	12
E989R-UPC	12 x 12 x 6	2	11 <sup>15</sup> / <sub>16</sub>	11 <sup>7</sup> / <sub>8</sub>	11 <sup>7</sup> / <sub>16</sub>	6	0.265	0.185		X	10

\*Gaskets are FIP (foam in place).

## Switch and junction boxes

### Large PVC junction boxes – NEMA 4X

Large PVC junction boxes are fabricated from Type II PVC sheet using a unique technology. Reduce the use of steel boxes and keep your wiring connections clean, safe and dry using these high-quality, fully gasketed junction boxes.

#### Features and benefits:

- PVC Type II material with “Uni-Body” construction and penetration welding providing a very strong, durable enclosure
- UL94V-0 flame rating
- Suitable for exposure of up to 90° C
- PVC material enables the use of standard solvent cements for fitting attachment
- Junction boxes are available with or without mounting flanges
- Individual mounting feet are available and provided in kits of four
- Custom features such as windows or panel mounts are available
- Custom sizes are also available upon request
- Made in the USA

**Note:** Not rated for pedestrian traffic.

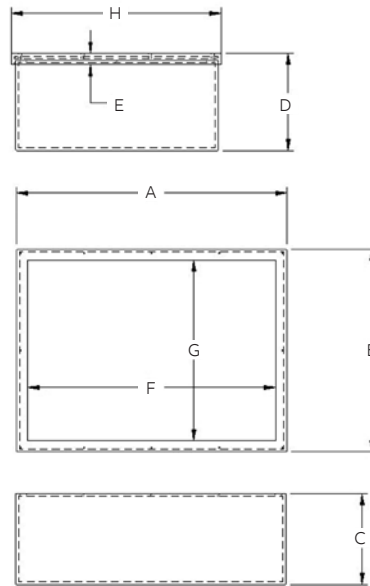
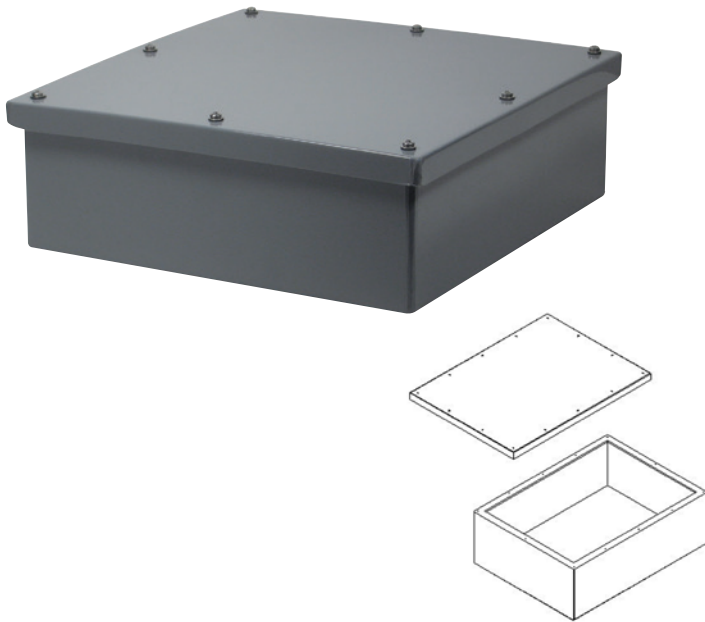

#### Large PVC junction boxes – NEMA 4X

Cat. No.	Dimensions (in.)								Std. Wt. (lbs.)
	A	B	C	D	E	F	G	H	
EP12128	12	12	8	8.25	1.00	10.5	10.5	12.75	11
EP181812	18	18	12	12.25	1.00	16	16	18.75	21
EP201808	20	18	8	8.25	1.00	18	16	18.75	20
EP202008	20	20	8	8.25	1.00	18	18	20.75	22
EP241808	24	18	8	8.25	1.00	22	16	18.75	24
EP242008	24	20	8	8.25	1.00	21.5	17.5	20.75	25
EP242408	24	24	8	8.25	1.00	21.5	21.5	24.75	29
EP302408	30	24	8	8.25	1.00	27.5	21.5	24.75	34
EP362408	36	24	8	8.25	1.00	33.5	21.5	24.75	39

#### Accessories

Cat. No.	Description	Std. Wt. (lbs.)
ESMFK-1	“CleverMount” Mounting feet (Four feet and fasteners)	5

## Switch and junction boxes

### Single-gang FS boxes

**Features and benefits:**

- For dead-end terminations
- All sizes take standard covers and accessories or devices
- Integral mounting feet provide easy mounting

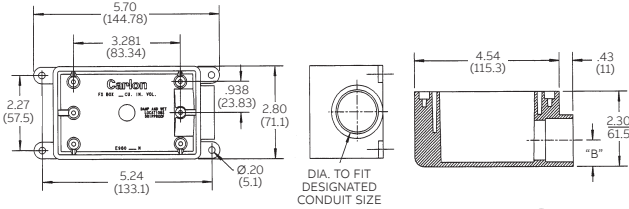

Type FSE

	Cat. No.	Size (in.)	Vol. Cu. (in.)	Std. Ctn.
	E980DFN	1/2	19	10
	C980DFN-CTN	1/2	18	12
	E980EFN	3/4	19	10
	C980EFN-CTN	3/4	18	12
	E980FFN	1	19	18
	C980FFN-CTN	1	18	8
	E980FFN-CAR	1	19	10

Canada only.

**Features and benefits:**

- For through terminations
- All sizes take standard covers and accessories or devices
- Integral mounting feet provide easy mounting

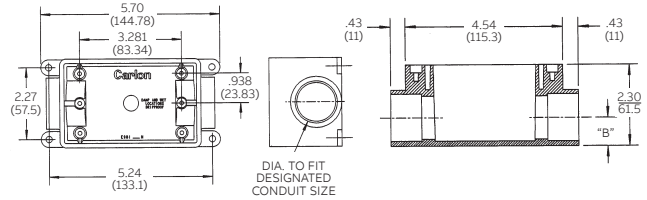

Type FSC

	Cat. No.	Size (in.)	Vol. Cu. (in.)	Std. Ctn.
	E981DFN	1/2	19	15
	C981DFN-CTN	1/2	18	12
	E981EFN	3/4	19	15
	C981EFN-CTN	3/4	18	12
	E981FFN	1	19	18
	E981FFN-CAR	1	19	10
	C981FFN-CTN	1	18	8

Canada only.

**Features and benefits:**

- For multiple dead-end circuit terminations or where additional support is required in stub-up applications
- All sizes take standard covers and accessories or devices
- Integral mounting feet provide easy mounting

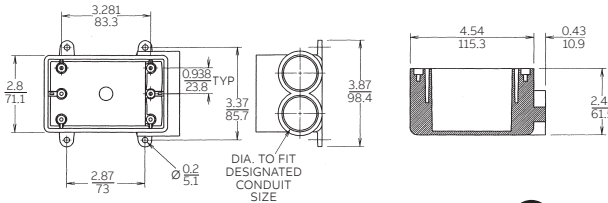

Type FSS

	Cat. No.	Size (in.)	Vol. Cu. (in.)	Std. Ctn.
	E982DFN	1/2	19	10
	C982DFN-CTN	1/2	18	12
	E982EFN	3/4	19	10
	C982EFN-CTN	3/4	18	12
	E982FFN	1	19	10
	C982FFN-CTN	1	18	8

Canada only.

**Features and benefits:**

- For multiple through-circuit terminations or where additional support is required in stub-up applications
- All sizes take standard covers and accessories or devices
- Integral mounting feet provide easy mounting

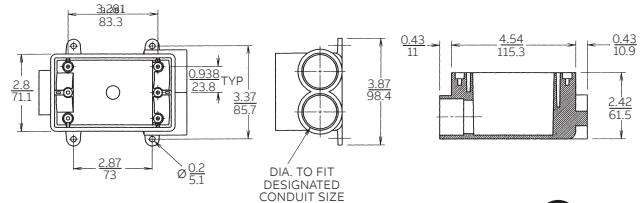

Type FSCC

	Cat. No.	Size (in.)	Vol. Cu. (in.)	Std. Ctn.
	E979DFN-CAR	1/2	19	10
	C979DFN	1/2	18	15
	E979EFN-CAR	3/4	19	10
	C979EFN	3/4	18	15
	E979FFN	1	19	15
	C979FFN	1	18	15

Canada only.

## Switch and junction boxes

### Single-gang FD deep device boxes

**Features and benefits:**

- For terminations where hub requirements vary according to application – hubs easily made with flared wood bit or hole saw
- All sizes take standard covers and accessories or devices
- Integral mounting feet provide easy mounting

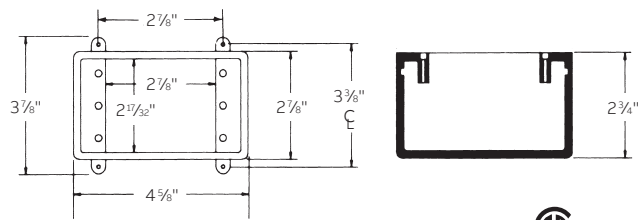

**SP**  
LR31146  
Where noted by

**UL**  
LISTED  
E11461

Type FD

Cat. No.	Size (in.)	Vol. Cu. (in.)	Std. Ctn.
E9801	N/A	25	10
CE9801-CTN	N/A	25	10
C9801-347	N/A	25	10

Canada only.

**Features and benefits:**

- For through terminations where large devices or additional wiring capacity is required
- All sizes take standard covers and accessories or devices
- Integral mounting feet provide easy mounting

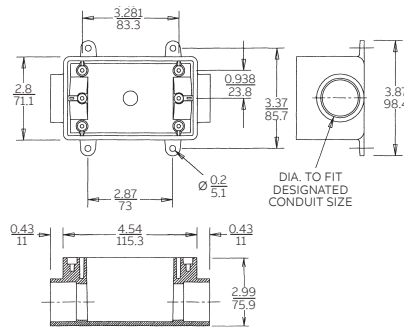

**SP**  
LR31146  
Where noted by

**UL**  
LISTED  
E11461

Type FDC

Cat. No.	Size (in.)	Vol. Cu. (in.)	Std. Ctn.
E9811DN	1/2	25	10
C9811DN	1/2	25	10
E9811EN	3/4	25	10
C9811EN	3/4	25	10
E9811FN	1	25	10
C9811FN	1	25	10

Canada only.

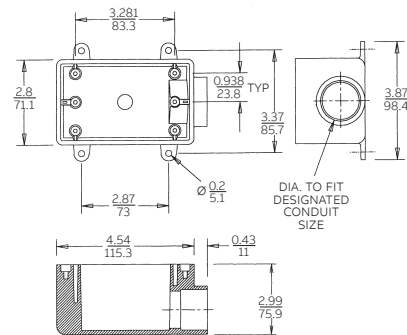

**SP**  
LR31146  
Where noted by

**UL**  
LISTED  
E11461

Type FDE

Cat. No.	Size (in.)	Vol. Cu. (in.)	Std. Ctn.
E9801DN	1/2	25	10
C9801DN	1/2	25	10
E9801EN	3/4	25	10
C9801EN	3/4	25	10
E9801FN	1	25	10
C9801FN	1	25	10

Canada only.

**Features and benefits:**

- For dead-end terminations where large devices or additional wiring capacity is required
- All sizes take standard covers and accessories or devices
- Integral mounting feet provide easy mounting



## Switch and junction boxes

### Two-gang FS boxes

**Features and benefits:**

- For through terminations where two devices or additional wiring capacity is required
- All sizes take standard covers and accessories or devices
- Integral mounting feet provide easy mounting

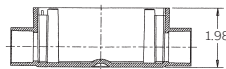
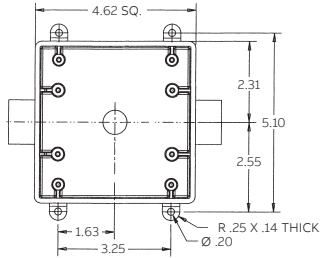

LR31146  
Where noted by 🇨🇦



E11461

Type 2FSC

Cat. No.	Size (in.)	Vol. Cu. (in.)	Std. Ctn.
E9812D	1/2	32	10
🇨🇦 CE9812D-CTN	1/2	32	10
E9812E	3/4	32	10
🇨🇦 CE9812E-CTN	3/4	32	10
E9812F	1	32	10
🇨🇦 C9812F	1	32	10

🇨🇦 Canada only.



**Features and benefits:**

- For dead-end terminations where two devices or additional wiring capacity is required
- All sizes take standard covers and accessories or devices
- Integral mounting feet provide easy mounting

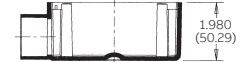
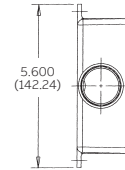
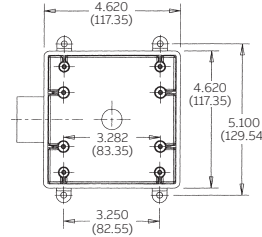

LR31146  
Where noted by 🇨🇦



E11461

Type 2FSE

Cat. No.	Size (in.)	Vol. Cu. (in.)	Std. Ctn.
E9802D	1/2	32	10
🇨🇦 CE9802D-CTN	1/2	32	10
E9802E	3/4	32	10
🇨🇦 CE9802E-CTN	3/4	32	10
E9802F	1	32	10
C9802F	1	32	1

🇨🇦 Canada only.



**Features and benefits:**

- For terminations where hub requirements vary according to application – hubs easily made with flared wood bit or hole saw
- All sizes take standard covers and accessories or devices
- Integral mounting feet provide easy mounting

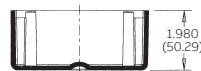
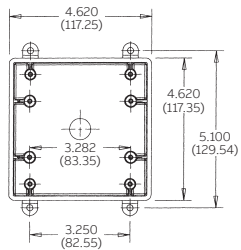

LR31146  
Where noted by 🇨🇦



E11461

Type FS

Cat. No.	Size (in.)	Vol. Cu. (in.)	Std. Ctn.
E9802	N/A	32	10
🇨🇦 CE9802	N/A	32	10



🇨🇦 Canada only.

### Blank covers

**Features and benefits:**

- Fits Carlon single-gang FS boxes
- Supplied with stainless steel mounting screws and gasket

**Single-gang**

Cat. No.	Color	Std. Ctn.	Std. Wt. (lbs.)
E980CN-CAR	Gray	12	1.60
E980CM-CAR	White	12	1.60



**Features and benefits:**

- Fits Carlon two-gang FS boxes, other non-metallic and metallic FS boxes
- Supplied with stainless steel mounting screws and gasket

**Two-gang**

Cat. No.	Color	Std. Ctn.	Std. Wt. (lbs.)
E9802CN-CAR	Gray	10	2.17



# Straps, clamps and accessories

## Snap Strap™ conduit support straps



Carlson's Snap Strap offers a unique support strap designed especially for the installation of PVC conduit. Also usable for installations of rigid steel. This high-strength, non-metallic clamp enables conduit to expand and contract freely, eliminating the bowing commonly seen from the expansion and contraction of conduit caused by varying temperature changes. Finished installations have a neat, attractive appearance on exposed applications.

To be used in accordance with conduit spacing requirements per NEC® Section 352.30 and 12-1114 of the CEC. This part is not supplied with screws.

- UV inhibited for use in direct sunlight

NEC and National Electrical Code are registered trademarks of the National Fire Protection Association, Inc.

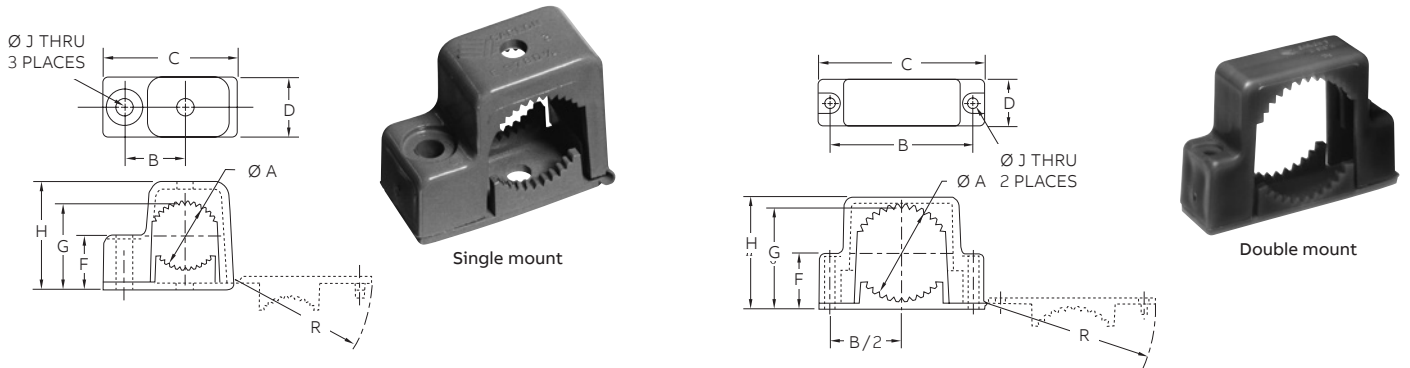

**Single mount**

Cat. No.	Size in. (mm)	Std. Ctn.	Std. Wt. (lbs.)	Dimensions in. (mm)								
				A	B	C	D	F	G	H	J	R
E978DC-CAR	1/2	40	1	0.80	0.75	1.63	.75	.68	1.08	1.36	.21	1.67
	(16)			(20.3)	(1.90)	(41.4)	(19.1)	(14.9)	(25.1)	(34.5)	(5.33)	(42.4)
E978EC-CAR	3/4	40	3	1.00	.88	1.92	.75	.79	1.29	1.58	.21	1.96
	(21)			(25.4)	(22.4)	(48.7)	(19.1)	(17.8)	(30.4)	(39.9)	(5.33)	(49.8)
E978FC-CAR	1	30	4	1.20	1.02	2.17	.75	.92	1.54	1.84	.21	2.22
	(27)			(30.5)	(25.9)	(55.1)	(19.1)	(21.1)	(36.3)	(46.7)	(5.33)	(56.3)

**Double mount**

Cat. No.	Size in. (mm)	Std. Ctn.	Std. Wt. (lbs.)	Dimensions in. (mm)								
				A	B	C	D	F	G	H	J	R
E978GC-CAR	1 1/4	15	4	1.66	2.75	3.23	1.00	1.07	1.90	2.15	.218	3.28
	(35)			(42.16)	(69.9)	(82.0)	(25.4)	(24.1)	(45.2)	(54.61)	(5.54)	(83.3)
E978HC-CAR	1 1/2	15	5	1.92	3.05	3.53	1.00	1.20	2.16	2.40	.218	3.58
	(41)			(48.77)	(77.5)	(89.7)	(25.4)	(27.4)	(51.8)	(60.96)	(5.54)	(90.9)
E978JC-CAR	2	10	5	2.34	3.50	4.00	1.00	1.43	2.59	2.86	.218	4.06
	(53)			(59.44)	(88.9)	(101.6)	(25.4)	(33.3)	(63.0)	(72.64)	(5.54)	(103.1)

## Straps, clamps and accessories

### Non-metallic clamps



Non-metallic clamps offer the same chemical resistance as Carlon non-metallic conduits for a complete, corrosion-resistant system.

To be used in accordance with conduit spacing requirements per NEC® Section 352.30 and 12-1114 of the CEC.

- UV inhibited for use in direct sunlight

NEC and National Electrical Code are registered trademarks of the National Fire Protection Association, Inc.

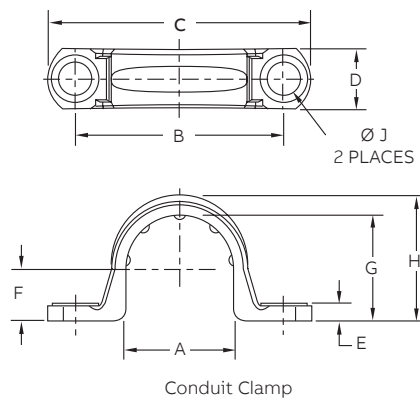

Conduit Clamp

#### Conduit clamps

Cat. No.	Size in. (mm)	Std. Ctn.	Std. Wt. (lbs.)	Dimensions in. (mm)								
				A	B	C	D	E	F	G	H	J
E977DC	1/2	100	1.2	0.892	1.71	2.16	.50	.14	.42	.866	1.04	.260
	(16)			(22.6)	(43.4)	(54.8)	(12.7)	(3.5)	(10.6)	(21.9)	(26.4)	(6.6)
E977EC	1/4	100	1.4	1.102	1.97	2.40	.50	.14	0.525	1.076	1.255	0.26
	(21)			(27.9)	(50.0)	(60.9)	(12.7)	(3.5)	(13.3)	(27.3)	(31.8)	(6.6)
E977FC	1	100	2	1.39	2.25	2.81	.594	.14	0.658	1.342	1.574	0.26
	(27)			(35.3)	(57.1)	(71.3)	(15.0)	(3.5)	(16.7)	(34.0)	(39.9)	(6.6)
E977GC	1 1/4	50	5	1.714	2.68	3.28	0.64	.15	0.83	1.687	1.89	.32
	(35)			(43.5)	(68.0)	(83.3)	(16.2)	(3.8)	(21.0)	(42.8)	(48.0)	(8.1)
E977HC	1 1/2	50	6	1.92	2.82	3.44	.70	0.15	0.97	1.93	2.12	.312
	(41)			(48.7)	(71.6)	(87.3)	(17.7)	(3.8)	(24.6)	(49)	(53.8)	(7.9)
E977JC	2	25	4.5	2.54	3.54	4.18	.76	.16	1.05	2.29	2.49	.315
	(53)			(64.5)	(89.9)	(106.1)	(19.3)	(4.0)	(26.6)	(58.1)	(63.2)	(8)
E977KC-CAR	2 1/2	25	1.4	2.86	4.50	5.46	1.00	0.20	1.43	2.86	3.12	.36
	(63)			(72.6)	(114.3)	(138.7)	(25.4)	(5.08)	(36.3)	(72.6)	(79.2)	(9.14)
E977LC-CAR	3	20	1.4	3.47	5.00	6.00	1.00	.20	1.74	3.48	3.70	.36
	(78)			(88.2)	(127.0)	(152.4)	(25.4)	(5.08)	(44.3)	(88.4)	(94.0)	(9.14)
E977NC-CAR	4	15	12.2	4.366	6.15	7.20	1.00	.20	2.32	4.50	4.70	.36
	(103)			(110.9)	(156.2)	(182.9)	(25.4)	(5.08)	(58.8)	(114.3)	(119.4)	(9.14)

**Note:** Some clamp applications require two screws, two nuts and two washers.

## Straps, clamps and accessories

### Carlton masonry pipe clamps

Carlton masonry pipe clamps make installations faster and easier by eliminating the use of bolts and anchors. The one-piece design features an anchoring projection designed to push into a  $\frac{5}{16}$ " drill hole.

The clamps are used to securely support pipe/conduit and electrical cables on concrete and masonry block, and unlike metallic clamps Carlton masonry clamps won't rust or corrode.

Carlton masonry pipe clamps are available in sizes  $\frac{1}{2}$ " and  $\frac{3}{4}$ " and are ideal for commercial applications such as schools, hospitals, airports, condominiums, hotels, airports, office buildings and casinos.

#### Features and benefits:

- One-piece design
- Material: Nylon PA6
- Color: Gray
- Flame resistance: V2
- Anchor length: 1.2" threaded
- Drill hole:  $\frac{5}{16}$ "

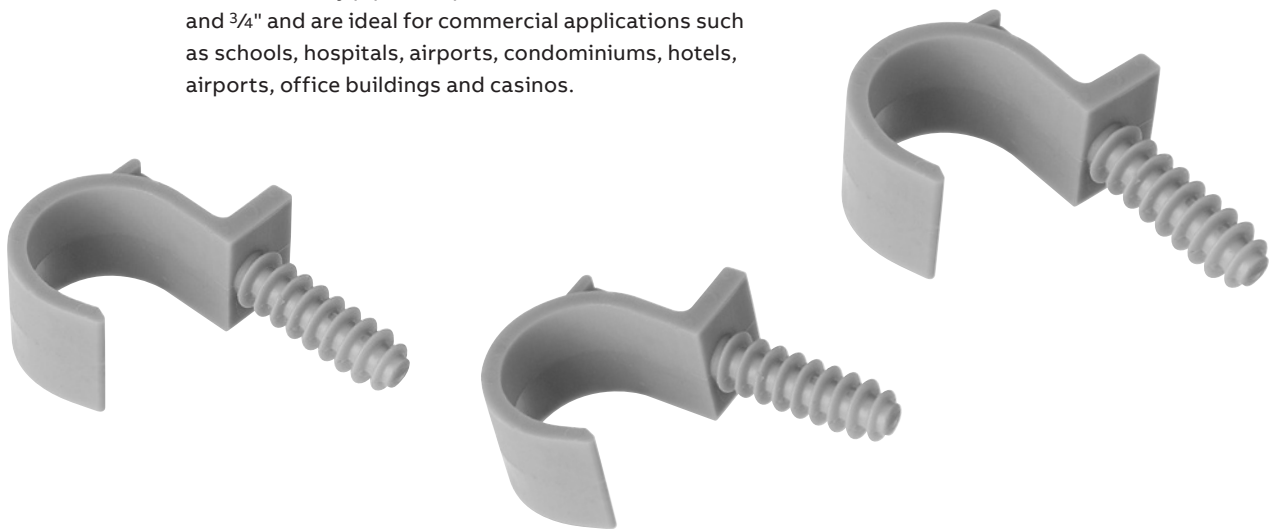

## Installation

**Note:** Follow NEC® guidelines for conduit clamp spacing.

01 Using a  $\frac{5}{16}$ " masonry drill bit, drill a hole into the concrete.

02 Tap clamp with hammer until fully inserted.

03 Conduit, pipe or cable



### Carlton masonry pipe clamps

Cat. No.	Size (in.)	Std. Ctn.	Std. Wt. (lbs.)
E977NDC-CTN	$\frac{1}{2}$	12 (Equals 12 bags of 5 clamps)	1.2
E977NEC-CTN	$\frac{3}{4}$	12 (Equals 12 bags of 5 clamps)	1.3

NEC and National Electrical Code are registered trademarks of the National Fire Protection Association, Inc.

## Straps, clamps and accessories

### Slip meter risers

Carlton slip meter risers are designed for use in electrical service entrance applications. They provide solutions for applications requiring a non-rigid connection, with incoming service conduit diameters ranging from 2" to 4". The slip meter risers are fitted with a terminal adapter for easy installation at the service entrance location and provide a low-cost method to comply with NEC® 300.5(J), which requires protection for buried cables in areas subject to ground movement due to frost or trench settling.

**Note:** Meter box is not included.



#### Slip meter risers

#### Features and benefits:

- Designed to provide faster and easier underground service entrance installations
- Provides cable protection from ground movement
- Accommodates incoming service conduit diameters ranging from 2" to 4"
- Fitted with terminal adapters for easy installing
- Allows ground water in raceway system to drain
- Complies with NEC® 300.5 paragraph 4, Schedule 80 rated

### Article 300 – Wiring methods

#### (J) Ground movement

Where direct buried conductors, raceways, or cables are subject to movement by settlement or frost, direct buried conductors, raceways, or cables shall be arranged to prevent damage to the enclosed conductors or to equipment connected to the raceways.

#### (FPN)

This section recognizes "S" loops in underground direct burial to raceway transitions, expansion joints in raceway risers to fixed equipment, and, generally, the provision of flexible connections to equipment subject to settlement or frost heaves.

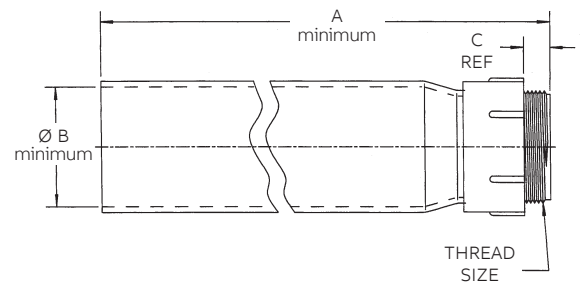

Cat. No.	Size (in.)	A Length	B (Minimum)	C	Thread size	Std. Carton Qty.	Std. Carton Wt.(lbs.)
E954JXX	2	24.00	2.492	.83	2" NPT	20	46
E954JXS (Split)	2	24.00	2.492	.83	2" NPT	1	2.2
E954KXX	2½	24.00	2.961	.81	2½" NPSC	10	28
E954LXX	3	24.00	3.616	.80	3" NPSC	10	35
E954LXS (Split)	3	24.00	3.616	.80	3" NPSC	10	36
E977NEC-CTN	4	24.00	4.859	.77	4" NPSC	5	23

NEC and National Electrical Code are registered trademarks of the National Fire Protection Association, Inc.

# Spacers

## Carlton® Snap-Loc® spacers

Carlton Snap-Loc duct spacers provide stability, consistent separation and relieve direct stress for duct materials encased in concrete and direct-burial applications.

Non-metallic Snap-Loc spacers are designed specifically for use with non-metallic duct, with maximum O.D. dimensions as specified in NEMA TC-2, TC-6 & 8 and ASTM F512. The innovative vertical and horizontal interlocking Snap-Loc design has tapered joining slots with maximum tolerances for easy jobsite assembly.



### Installation note

The spacers and Rebar holder are designed with a dovetail tongue-and-groove feature for easy installation.

If required to permanently fix the position of a group of Spacers and/or Rebar Holder, the following are recommended procedures:

1. Use Carlton Quick-Set cement glue during assembly or spot glue after assembly to secure.
2. During assembly, deform the edge of the tongue or groove portion of the dovetail slide with a pair of pliers or similar tool. This deformation will create an interference, restricting movement.
3. An assembled system may be wired together for additional support.

### Features and benefits:

- A side dovetail rail-and-groove design enabling side-by-side interchangeability of conduit spacer sizes while maintaining horizontal stability
- Locking keyways incorporated into intermediate spacers eliminate the need for costly top spacers in each size. The locking keyways provide for the use of a beaded strap that secures the top section of conduit
- 1" and 2" Snap-Loc reducers enable fixturing of 1" or 2" conduit inside larger spacers
- The Snap-Loc Rebar holder provides stabilization on large banks of spacers

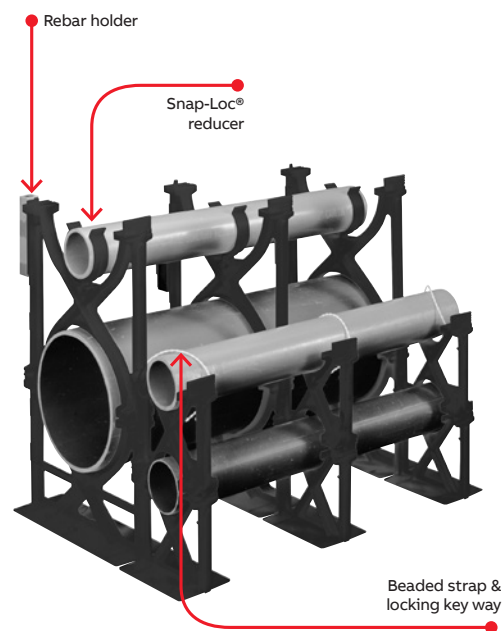

### Important:

The use of duct spacers for direct burial may result in excessive point deflections unless proper design engineering is applied, such as the proper compaction of the appropriate backfill material.

**Note:** Spacers are not UL® Listed



## Spacers

### Carlton Snap-Loc spacers

#### Dimensions – Base spacers

Cat. No.	Size (in.)	A (in.)	C (in.)	D (Dia.) (in.)	Std. Ctn.
S288JHN	2 x 1½	4.25	4.12	2.50	100
S288JN	2 x 2	4.25	4.62	2.50	100
S288JLN	2 x 3	4.25	5.62	2.50	100
S288LHN	3 x 1½	4.81	5.25	3.63	90
S288LJN	3 x 2	4.81	5.75	3.63	80
S288LLN	3 x 3	4.81	6.75	3.63	60
S288NFN	4 x 1	4.50	5.75	4.63	70
S288NHN	4 x 1½	5.31	6.25	4.63	50
S288NJN	4 x 2	5.31	6.75	4.63	50
S288NLN	4 x 3	5.31	7.75	4.63	60
S288PHN	5 x 1½	5.84	7.31	5.69	50
S288PJN	5 x 2	5.84	7.81	5.69	60
S288PLN	5 x 3	5.84	8.81	5.69	50
S288RHN	6 x 1½	6.38	8.38	6.75	50
S288RJN	6 x 2	6.38	8.88	6.75	50
S288RLN	6 x 3	6.38	9.88	6.75	40
S288SHN	8 x 1½	7.38	10.3	8.75	30
S288SJN	8 x 2	7.38	10.76	8.75	30

\* First number indicates trade size of duct, second number indicates separation between conduits or ducts.

#### Dimensions – Intermediate spacers

Cat. No.	Size (in.)	A (in.)	C (in.)	D (Dia.) (in.)	Std. Ctn.
S289JHN	2 x 1½	3.88	4.12	2.50	120
S289JN	2 x 2	4.38	4.62	2.50	100
S289JLN	2 x 3	5.38	5.62	2.50	80
S289LHN	3 x 1½	5.01	5.25	3.63	100
S289LJN	3 x 2	5.51	5.75	3.63	80
S289LLN	3 x 3	6.51	6.75	3.63	60
S289NFN	4 x 1	5.51	5.73	4.63	70
S289NHN	4 x 1½	6.01	6.25	4.63	60
S289NJN	4 x 2	6.51	6.75	4.63	60
S289NLN	4 x 3	7.51	7.75	4.63	50
S289PHN	5 x 1½	7.07	7.31	5.69	50
S289PJN	5 x 2	7.57	7.81	5.69	50
S289PLN	5 x 3	8.57	8.81	5.69	30
S289RHN	6 x 1½	8.14	8.38	6.75	50
S289RJN	6 x 2	8.64	8.88	6.75	40
S289RLN	6 x 3	9.64	9.88	6.75	30
S289SHN	8 x 1½	10.14	10.3	8.75	30
S289SJN	8 x 2	10.64	10.76	8.75	30

\* First number indicates trade size of duct, second number indicates separation between conduits or ducts.

## Accessories

#### Snap-Loc reducer



Cat. No.	Size (in.)	Std. Ctn.
S287F	1	100
S287J	2	100

#### Rebar holder

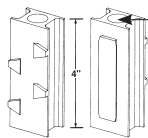

Hole Dia. =  
.688 min.  
.750 max.

Cat. No.	Std. Ctn.
S258RH	100

#### Beaded strap



15" in length

Cat. No.	Std. Ctn.
S28612	1 Bag of 250

## Specifications

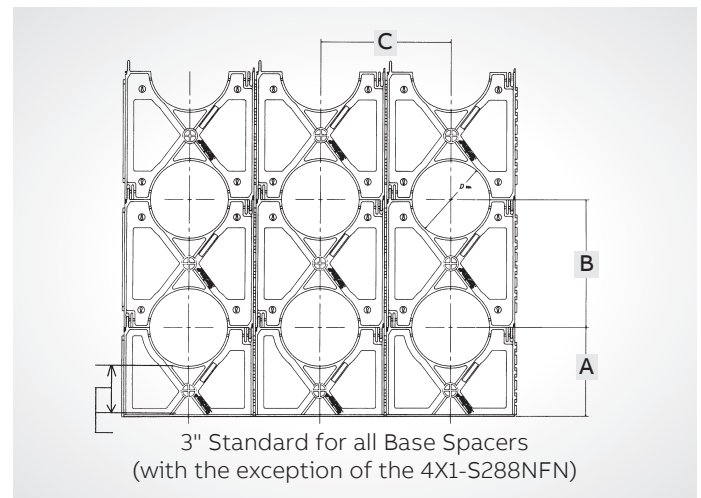

#### Suggested Specification:

(Duct) (Conduit) bank shall be encased in concrete with at least three inches of concrete at the top and bottom and two inches on each side. A horizontal and vertical separation between the ducts of \_\_\_\_\* inches shall be maintained by installing high-impact spacers with horizontal and vertical locking intervals of \_\_\_\_\*\* feet.

\*Standard Separations of 1", 1½", 2" and 3" are available.

\*\*Preferred interval between spacer assemblies is 8 to 10 feet.



## Spacers

### Carlton® Snap-N-Stac™ combo spacers

Carlton Snap-N-Stac Combo Duct Spacers are specifically designed to replace the two-piece base and intermediate spacer system, by combining the conventional base and intermediate spacer into a single unit.

Manufactured out of highly engineered thermoplastic material, Snap-N-Stac Spacers are strong, durable and able to withstand the rigors of concrete construction. They feature an innovative horizontal and EXCLUSIVE vertical locking system, and can be used as either a base or intermediate spacer.

Snap-N-Stac Spacers are available in one-way, two-way and three-way configurations (one-way and three-way only available in sizes 2" and 4"). They accept 2", 3", 4", 5" and 6" pipe and can be installed horizontally, vertically or turned upright for unique duct bank configurations.

This NEW one-piece design makes underground duct bank installations faster and easier than the conventional two-piece system – saving material and labor costs.

Carlton Snap-N-Stac Combo Spacers...

The IDEAL solution for underground duct bank installations.

#### Features and benefits:

- Conventional base and intermediate spacer in a single unit
- Less inventory required
- EXCLUSIVE vertical locking system
- Horizontal locking system
- Installs horizontally or turned upright
- Molded-in rebar holder on two-way and three-way
- One-, two- and three-way configurations (one way and three-way only available in sizes 2" and 4")
- Five sizes: 2", 3", 4", 5" and 6"
- Reducer to accommodate smaller duct sizes
- Can be used as either an intermediate or base spacer
- Spacers interlock horizontally regardless of size
- Non-metallic, non-corrosive, non-conductive
- Strong and durable
- Easy to handle
- Fast installation

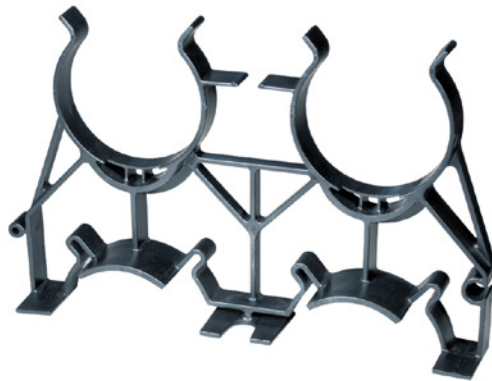

One-way



Three-way

### Installations

- 01 Horizontal Locking
- 02 Vertical Interlocking
- 03 With reducer

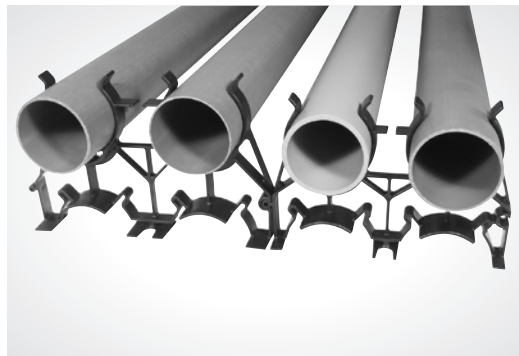

01

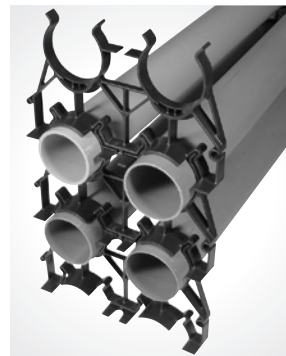

02

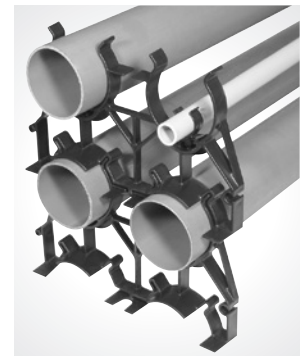

03

## Spacers

Carlton Snap-N-Stack combo spacers

### Installation instructions

#### Important:

1. Snap-N-Stack Spacers are recommended for concrete-encased applications only.
2. The use of duct spacers for direct burial may result in excessive point deflections unless proper design engineering is applied, such as the proper compaction of the appropriate backfill material.

#### Vertical interlocking

Slide spacers together “feet facing feet” or “feet opposite.”



#### Molded-in Rebar holder

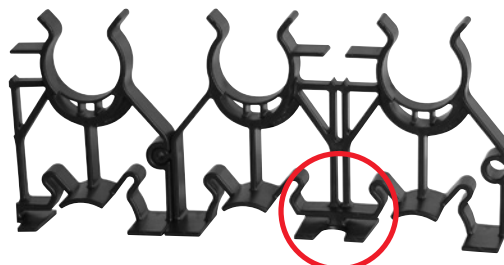
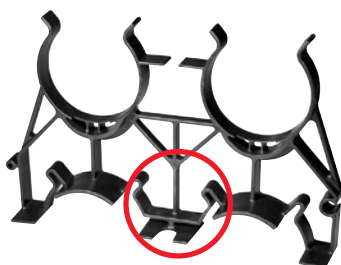

## Spacers

### Carlton Snap-N-Stac combo spacers

#### Installation instructions

##### 01 Vertical free standing

If spacers are installed using free-standing method, it is recommended to install the spacer on the upper row mid-way between the two spacers on the bottom row.

01

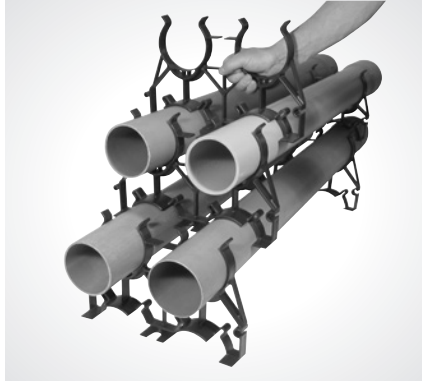

##### 02 Reducer

1" and 2" Snap-Loc reducers enable fixturing of 1" and 2" conduit inside of larger spacers.

02

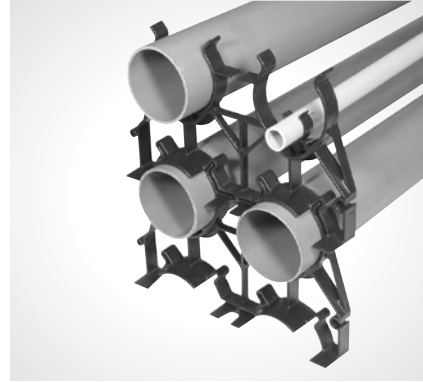

##### 03 Transition to various duct sizes

Install spacers side-by-side by inserting the male adapter into the female adapter.

03



##### 04 Odd number of ducts

Two-way spacers, size 2" and 4" only, can easily be cut apart to produce two one-way spacers. Create three-way and five-way spacers using the one-way spacer. Install spacers side-by-side by inserting the male adapter into the female adapter.



04

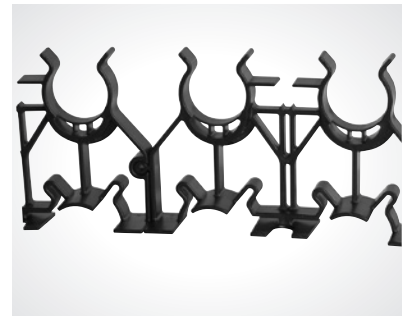

## Spacers

### Carlton Snap-N-Stack combo spacers

#### Carlton Snap-N-Stack combo spacers

Cat. No.	Description	Size (in.)	Separation (in.)	Std. Ctn.	Std. Wt. (lbs.)
SP2W20-1		2	2	56	15.0
SP2W30-1		2	3	40	13.0
SP4W15-1	1-way spacers	4	1½	26	9.6
SP4W20-1		4	2	20	10.0
SP4W30-1		4	3	20	9.4
SP2W20-2*		2	2	56	28.5
SP2W30-2*		2	3	40	23.8
SP3W20-2		3	2	40	24.0
SP3W30-2		3	3	24	17.9
SP4W15-2*		4	1½	26	18.3
SP4W20-2*	2-way spacers	4	2	24	18.8
SP4W30-2*		4	3	20	17.6
SP5W20-2		5	2	20	17.2
SP5W30-2		5	3	14	15.5
SP6W20-2		6	2	12	12.8
SP6W30-2		6	3	12	14.1
SP2W20-3		2	2	36	28.5
SP2W30-3		2	3	18	17.8
SP4W15-3	3-way spacers	4	1½	18	19.4
SP4W20-3		4	2	16	19.3
SP4W30-3		4	3	14	19.1

\*Can be cut apart to make (2) one-way spacers.

#### Technical information

Cat. No.	Duct size (in.)	Duct O.D.	Duct-to-Duct Spacing		Center-to-Center Spacing		Horizontal (in.)	Bottom of trench to bottom of duct	Bottom of Trench to center of bottom of duct	Overall length
			Horizontal duct positions	Vertical (in.)	Horizontal (in.)	Vertical (in.)				
SP2W20-1	2	2.375	1	2	2	2.19	2.19	3.13	4.25	4.38
SP2W30-1	2	2.375	1	3	3	2.69	2.69	4.13	5.25	5.38
SP4W15-1	4	4.500	1	1.5	1.5	3.00	3.00	3.38	5.56	6.00
SP4W20-1	4	4.500	1	2	2	3.25	3.25	3.88	6.06	6.50
SP4W30-1	4	4.500	1	3	3	3.75	3.75	4.88	7.06	7.50
SP2W20-2	2	2.375	2	2	2	4.38	4.38	3.13	4.25	8.75
SP2W30-2	2	2.375	2	3	3	5.38	5.38	4.13	5.25	10.75
SP3W20-2	3	3.500	2	2	2	5.50	5.50	3.63	5.38	11.00
SP3W30-2	3	3.500	2	3	3	6.50	6.50	4.63	6.38	13.00
SP4W15-2	4	4.500	2	1.5	1.5	6.00	6.00	3.38	5.56	12.00
SP4W20-2	4	4.500	2	2	2	6.50	6.50	3.88	6.06	13.00
SP4W30-2	4	4.500	2	3	3	7.50	7.50	4.88	7.06	15.00
SP5W20-2	5	5.500	2	2	2	7.56	7.56	4.38	7.25	15.12
SP5W30-2	5	5.500	2	3	3	8.56	8.56	5.38	8.25	17.14
SP6W20-2	6	6.625	2	2	2	8.62	8.62	4.13	7.38	17.25
SP6W30-2	6	6.625	2	3	3	9.62	9.62	5.13	8.38	19.25
SP2W20-3	2	2.375	3	2	2	4.38	4.38	3.13	4.25	13.13
SP2W30-3	2	2.375	3	3	3	5.38	5.38	4.13	5.25	16.13
SP4W15-3	4	4.500	3	1.5	1.5	6.00	6.00	3.38	5.56	18.00
SP4W20-3	4	4.500	3	2	2	6.50	6.50	3.88	6.06	19.50
SP4W30-3	4	4.500	3	3	3	7.50	7.50	4.88	7.06	22.50

#### How to interpret the part number:

Position 1	Position 2	Position 3	Position 4
Product type	Duct size	Duct-to-duct spacing horizontal and vertical	Horizontal duct positions
SP = Spacer	2W = 2" width	15 = 1½"	-1 = one-way
	3W = 3" width	20 = 2"	-2 = two-way
	4W = 4" width	30 = 3"	-3 = three-way
	5W = 5" width		
	6W = 6" width		

## Accessories

#### Snap-Loc reducer



Cat. No.	Size (in.)	Std. Ctn.
S287F	1	100
S287J	2	100

#### Beaded strap

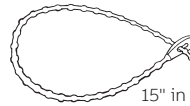

Cat. No.	Std. Ctn.
S28612	100

15" in length

## Technical information

Typical properties of conduit raw material compound

Thermal	ASTM Test	Typical values
Co-efficient of thermal expansion-inch/inch/° F (properties @ 73.4° F)	D696	3.38 x 10 <sup>-5</sup>
Heat distortion ° F at 264 psi	D648	160° F
Thermal conductivity BTU (hr.) (ft.) (° F/in.)	N/A	1.3

Mechanical	ASTM Test	Typical values
Specific gravity	D792	1.43 - 1.6
Tensile strength (psi) @ 73.4° F	D648	5,000-6,500
Izod impact ft lbs./in. of notch	D256	.65 - 1.5
Flexural strength (psi)	D790	12,500
Compressive strength (psi)	D695	9,000
Hardness (Durometer D)	D2240	85

ELECTRICAL	ASTM Test	Typical values
Dielectrical strength volts/mil	D149	1100
Dielectric constant 60 CPS @ 30° C	D150	4.00
Power factor 60 CPS @ 30° C	D150	1.93

Impedance (Volts lost per Ampere per 100 feet)	3Ø90% P.F.	80% P.F.	1Ø90% P.F.	80% P.F.
Steel conduit	.0118	.0123	.0136	.0142
Schedule 40	.0105	.0106	.0121	.0122

Using 250 kcmil copper conductor. Comparable values for other conductor sizes.

## Weight comparison

Carlson Schedule 40 rigid non-metallic conduit compared to other conduit in pounds per 100 feet (approx.)

Nom. size (in.)	Carlson Schedule 40 rigid non-metallic conduit	Carlson Schedule 80 rigid non-metallic conduit	Aluminum	Electrical metallic tubing (EMT)	Intermediate metal conduit (IMC)	Rigid metal conduit (RMC)
1/2	18	22	27	30	57	79
3/4	23	29	36	46	78	105
1	35	43	53	66	112	153
1 1/4	48	60	70	96	114	201
1 1/2	57	72	86	112	176	246
2	76	100	116	142	230	334
2 1/2	125	153	183	230	393	527
3	164	212	239	270	483	690
3 1/2	198		288	350	561	831
4	234	310	340	400	625	982
5	317	431	465	Not made	Not made	1344
6	412	592	612	Not made	Not made	1770

## Technical information

### Wire fill

— Maximum number of conductors in Schedule 40 PVC conduit (Based on Table 1, Chapter 9 of the NEC®)

Type letters	Conductor size AWG,														Trade size	
	KCMIL	1/2	3/4	1	1 1/4	1 1/2	2	2 1/2	3	3 1/2	4	4 1/4	5	6	8	
THWN	14	13	24	39	69	94	154									
	12	10	18	29	51	79	114	164								
THHN	10	6	11	18	32	44	73	194	160							
	8	3	5	9	19	22	36	51	71	106	136					
FEP (14 thru 2)	6	1	4	6	11	15	26	37	57	76	98	125	154			
	4	1	2	4	7	9	16	22	35	47	60	75	94	137	236	
	3	1	1	3	6	8	13	19	29	39	51	64	90	116	201	
FEPB (14 thru 8)	2	1	1	3	5	7	11	16	25	33	43	54	67	97	169	
	1		1	1	3	5	9	12	18	25	32	49	59	72	125	
	1/0		1	1	3	4	7	10	15	21	27	33	42	61	105	
PFA (14 thru 4/0)	2/0		1	1	2	3	6	8	13	17	22	28	35	51	88	
	3/0		1	1	1	3	5	7	11	14	18	23	29	42	73	
	4/0		1	1	1	2	4	6	9	12	15	19	24	35	61	
PFAH (14 thru 4/0)	250			1	1	1	3	4	7	10	12	16	20	28	49	
	300			1	1	1	3	4	6	8	11	13	17	24	42	
	350			1	1	1	2	3	5	7	9	12	15	21	37	
Z (14 thru 4/0)	400				1	1	1	3	5	6	8	10	13	19	33	
	500				1	1	1	2	4	5	7	9	11	16	27	
	600				1	1	1	1	3	4	5	7	9	13	22	
XHHW (4 thru 500)	700					1	1	1	3	4	5	6	8	11	19	
	750					1	1	1	2	3	4	6	7	11	19	
	6	1	3	5	9	13	21	30	47	63	81	102	128	185	320	
XHHW	600				1	1	1	1	3	4	5	7	9	13	22	
	700					1	1	1	3	4	5	6	7	11	19	
	750					1	1	1	2	3	4	6	7	10	18	

NEC and National Electrical Code are registered trademarks of the National Fire Protection Association, Inc.

## Technical information

### Wire fill (continued)

Maximum number of conductors in Schedule 80 PVC conduit (Based on Table 1, Chapter 9 of the NEC®)

Type I Letters	Conductor size AWG, KCMIL	Trade size									
		1/2	3/4	1	1 1/4	1 1/2	2	2 1/2	3	4	5
#14	THW	4	8	13	24	34	57	82	128		
	THHN	10	19	33	58	81	135	194	0		
12	THW	3	6	11	20	28	47	67	105	183	
	THHN	8	14	24	43	60	100	144	0		
10	THW	3	5	9	16	22	37	54	85	148	
	THHN	5	9	15	27	38	64	92	143		
8	THW	1	2	4	8	11	19	28	44	77	121
	THHN	1	4	7	13	18	31	45	70	123	195
6	THW	1	1	3	6	8	14	20	32	56	88
	THHN	1	3	5	9	13	22	32	50	88	140
4	THW	0	1	2	4	6	10	15	24	42	66
	THHN	1	1	3	6	8	13	20	31	54	86
3	THW	0	1	1	4	5	9	13	20	36	57
	THHN	1	1	2	5	7	11	17	26	46	73
2	THW	0	1	1	3	4	8	11	17	31	49
	THHN	1	1	1	4	5	9	14	22	38	61
1	THW	0	1	1	1	3	5	8	13	22	35
	THHN	0	1	1	3	4	7	10	16	28	45
0	THW	0	0	1	1	2	4	7	11	19	30
	THHN	0	1	1	2	3	6	8	13	24	38
00	THW	0	0	1	1	1	4	6	9	16	26
	THHN	0	1	1	1	3	5	7	11	20	32
000	THW	0	0	1	1	1	3	5	8	14	22
	THHN	0	0	1	1	2	4	6	9	16	26
0000	THW	0	0	1	1	1	3	4	6	11	18
	THHN	0	0	1	1	1	3	5	8	14	22
250	THW	0	0	0	1	1	1	3	5	9	14
	THHN	0	0	0	1	1	2	4	6	11	18
300	THW	0	0	0	1	1	1	3	4	8	13
	THHN	0	0	0	1	1	1	3	5	9	15
350	THW	0	0	0	1	1	1	2	4	7	11
	THHN	0	0	0	1	1	1	3	4	8	13
400	THW	0	0	0	0	1	1	1	3	6	10
	THHN	0	0	0	1	1	1	2	4	7	12
500	THW	0	0	0	0	1	1	1	3	5	8
	THHN	0	0	0	0	1	1	1	3	6	10
600	THW	0	0	0	0	0	1	1	1	4	7
	THHN	0	0	0	0	1	1	1	3	5	8
700	THW	0	0	0	0	0	1	1	1	3	6

NEC and National Electrical Code are registered trademarks of the National Fire Protection Association, Inc.



## Technical information

### Expansion and contraction

#### Temperature considerations for rigid non-metallic conduit compensation for linear expansion.

Like all construction materials, PVC will expand or contract with variations in temperatures. The coefficient of linear expansion in PVC conduit is  $3.38 \times 10^{-5}$  in./in./°F as compared to  $1.2 \times 10^{-5}$  for aluminum and  $.6 \times 10^{-5}$  for steel. An expansion fitting is needed whenever the change in length due to temperature variation will be  $\frac{1}{4}$ " or greater per 352.44 of the NEC.

Add 30°F to the estimated temperature range when conduit is installed in direct sunlight to allow for radiant heating.

An expansion fitting consists of two sections, one telescoping inside another. When installing expansion fittings, alignment of piston and barrel is important. Be sure to mount expansion fitting level for best performance.

For a vertical run, the expansion fitting must be installed close to the top of the run with the barrel jointing down, in order that rain water does not run into the opening. The lower end of the conduit run must be secured at the bottom so that any length change due to temperature variation will result in an upward movement.

#### Determine the piston opening

The expansion joint must be installed to allow both expansion and contraction of the conduit run.

The correct piston opening for any installation condition should use the following formula:

$$O = \left[ \frac{T_{\max} - T_{\text{installed}}}{\Delta T} \right] E$$

#### Example

380 ft. cf conduit is to be installed on the outside of a building exposed to the sun in a single straight run. It is expected that the conduit will vary in temperature from 0°F in the winter to 140°F in the summer (this includes the 30°F for radiant heating from the sun.) The installation is to be made at a conduit temperature of 90°F. From this table, a 140°F temperature change will cause a 5.7" length change in 100 ft. of conduit. The total change for this example is  $5.7" \times 3.8 = 21.67"$  which should be rounded to 22". The number of expansion fittings will be  $22" \times \text{fitting range (4" for Carlon trade sizes } \frac{1}{2}" \text{ through } 1\frac{1}{2}" \text{, and 8" for sizes 2" through 6")}$ . If the E945D fitting is used, the number will be  $22" / 4 = 5.50$  which should be rounded to 6. The fitting should be placed at 62 ft. intervals ( $380 / 6$ ). The proper piston setting at the time of installation is calculated as explained above.

$$O = \left[ \frac{140 - 90}{140} \right] 4.0 = 1.4 \text{ in.}$$

Insert the piston into the barrel to the maximum depth. Place a mark on the piston at the end of the barrel. To properly set the piston, pull the piston out of the barrel to correspond to the 1.4" calculated above. See drawing at left.

#### Summary

1. Anticipate expansion and contraction of PVC conduit in above ground, exposed installation.
2. Use an expansion fitting when length change due to temperature variation will be  $\frac{1}{4}$ " or greater per 352.44 of the NEC®.
3. PVC conduit expands 4.1" for each 100 feet of run and a 100°F temperature change.
4. Align expansion fitting with the conduit run to prevent binding.
5. Follow the instructions to set the piston opening.
6. Rigidly fix the outer barrel of the expansion fitting so it cannot move. Mount the conduit connected to the piston loosely enough to allow the conduit to move as the temperature changes.

NEC and National Electrical Code are registered trademarks of the National Fire Protection Association, Inc.

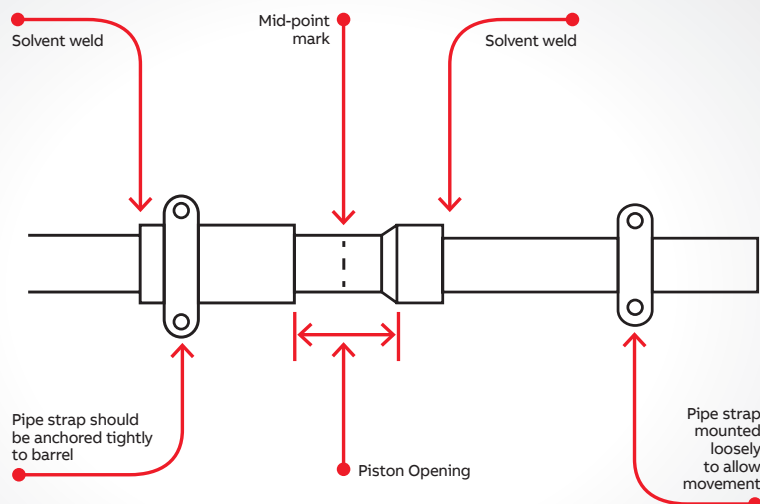

## Technical information

### Expansion and contraction

Expansion characteristics of PVC rigid non-metallic conduit coefficient of thermal expansion =  $3.38 \times 10^{-5}$  in./in./°F

Temperature change in degrees F	Length change in inches per 100 ft. of PVC conduit	Temperature change in degrees F	Length change in inches per 100 ft. of PVC conduit	Temperature change in degrees F	Length change in inches per 100 ft. of PVC conduit	Temperature change in degrees F	Length change in inches per 100 ft. of PVC conduit
5	0.2	55	2.2	105	4.2	155	6.3
10	0.4	60	2.4	110	4.5	160	6.5
15	0.6	65	2.6	115	4.7	165	6.7
20	0.8	70	2.8	120	4.9	170	6.9
25	1.0	75	3.0	125	5.1	175	7.1
30	1.2	80	3.2	130	5.3	180	7.3
35	1.4	85	3.4	135	5.5	185	7.5
40	1.6	90	3.6	140	5.7	190	7.7
45	1.8	95	3.8	145	5.9	195	7.9
50	2.0	100	4.0	150	6.1	200	8.1

## Technical information

### Corrosion resistance of Carlon Schedule 40 and Schedule 80 fittings

Carlon Schedule 40 and Schedule 80 fittings are generally acceptable for use in environments containing the chemicals below. These environmental resistance ratings are based upon tests where the specimens were placed in complete submergence in the reagent listed. Schedule 40 and Schedule 80 fittings can be used in many process areas where chemicals not on this list are manufactured or used because worker safety requirements dictate that any air presence or splashing be at a very low level.

**If there are any questions about specific suitability in a given environment, prototype samples should be tested under actual conditions.**

Chemical Environment					
Acetic Acid 0 – 20%	Bismuth Carbonate	Copper Fluoride	Hydrofluoric Acid 10%	Perchloric Acid 10%	Sodium Dichromate
Acetic Acid 20 – 30%	Black Liquor	Copper Nitrate	Hydrofluorosilicic Acid	Phenylhydrazine	Sodium Ferricyanide
Acetic Acid 30 – 60%	(Paper Industry)	Copper Sulfate	Hydrogen Phosphide	Hydrochloride	Sodium Ferrocyanide
Acetic Acid 80%	Bleach – 12.5% Active	Cottonseed Oil	Hydrogen Sulfide – Dry	Phosgene, Gas	Sodium Fluoride
Acetic Acid – Glacial	CL2	Cresylic Acid 50%	Hydrogen Sulfide – Aqueous Solution	Phosphoric Acid - 0 - 25%	Sodium Hydroxide
Acetic Acid Vapors	Borax	Crude Oil – Sour	Hydroquinone	Phosphoric Acid - 25 - 50%	Sodium Hypochlorite
Acetylene	Boric Acid	Crude Oil – Sweet	Hydroxylamine Sulfate	Phosphoric Acid - 50 - 85%	Sodium Nitrate
Adipic Acid	Brine	Deminerlized Water	Iodine	Photographic Chemicals	Sodium Nitrite
Alum	Breeder Pellets –	Dextrin	Kerosene	Plating Solutions	Sodium Sulfate
Aluminum Chloride	Dane. Fish	Dextrose	Lactic Acid 28%	Potassium Bicarbonate	Sodium Sulfide
Aluminum Fluoride	Bromic Acid	Diglycolic Acid	Lauryl Chloride	Potassium Bichromate	Sodium Thiosulfate (Hypo)
Aluminum Hydroxide	Bromine – Water	Disodium Phosphate	Lauryl Sulfate	Potassium Borate	Stannic Chloride
Aluminum Oxychloride	Butane	Ethyl Alcohol	Lead Acetate	Potassium Bromide	Stannous Chloride
Aluminum Nitrate	Butadiene	Ethylene Glycol	Lime Sulfur	Potassium Carbonate	Sulfur
Aluminum Sulfate	Butyl Alcohol	Fatty Acids	Linoleic Acid	Potassium Chloride	Sulfur Dioxide – Gas Dry
Ammonia-Dry Gas	Butyl Phenol	Ferric Chloride	Linseed Oil	Potassium Chromate	Sulfur Trioxide
Ammonium Bifluoride	Butylene	Ferric Nitrate	Lubricating Oils	Potassium Cyanide	Sulfuric Acid – 0 – 10%
Ammonium Carbonate	Butyric Acid	Ferric Sulfate	Magnesium Carbonate	Potassium Dichromate	Sulfuric Acid – 10 – 75%
Ammonium Chloride	Calcium Bisulfite	Ferrous Chloride	Magnesium Chloride	Potassium Ferricyanide	Sulfuric Acid – 75 – 90%
Ammonium Hydroxide 28%	Calcium Carbonate	Ferrous Sulfate	Magnesium Hydroxide	Potassium Ferrocyanide	Sulfurous Acid
Ammonium Metaphosphate	Calcium Chlorate	Fluorine Gas – Wet	Magnesium Nitrate	Potassium Fluoride	Tannic Acid
Ammonium Nitrate	Calcium Chloride	Fluorine Gas – Dry	Magnesium Sulfate	Potassium Hydroxide	Titanium Tetrachloride
Ammonium Persulfate	Calcium Hydroxide	Fluoroboric Acid	Maleic Acid	Potassium Nitrate	Triethanolamine
Ammonium Phosphate – Neutral	Calcium Hypochlorite	Fluorosilicic Acid	Malic Acid	Potassium Perborate	Trimethyl Propane
Ammonium Sulfate	Calcium Nitrate	Formaldehyde	Mercuric Chloride	Potassium Perchlorite	Trisodium Phosphate
Ammonium Sulfide	Calcium Sulfate	Formic Acid	Mercuric Cyanide	Potassium Permanganate 10%	Turpentine
Ammonium Thiocyanate	Carbonic Acid	Fructose	Mercurous Nitrate	Potassium Persulfate	Urea
Amyl Alcohol	Carbon Dioxide Gas – Wet	Gallic Acid	Mercury	Potassium Sulfate	Vinegar
Antraquinone	Carbon Dioxide – Aqueous Solution	Gas – Coke Oven	Methyl Sulfate	Propane	White Liquor (Paper Industry)
Antraquinonesulfonic Acid	Carbon Monoxide	Gas – Natural (Dry)	Methylene Chloride	Propyl Alcohol	Wines
Antimony Trichloride	Caustic Potash	Gas – Natural (Wet)	Mineral Oils	Silicic Acid	Zinc Chloride
Aqua Regia	Caustic Soda	Gasoline – Sour	Naphthalene	Silver Cyanide	Zinc Chromate
Arsenic Acid 80%	Chloracetic Acid	Gasoline – Refined	Nickel Chloride	Silver Nitrate	Zinc Cyanide
Arylsulfonic Acid	Chloral Hydrate	Glucose	Nickel Nitrate	Silver Plating Solutions	Zinc Nitrate
Barium Chloride	Chlorine Gas (Dry)	Glycerine (Glycerol)	Nitric Acid, Anhydrous	Sodium Acetate	Zinc Sulfate
Barium Hydroxide	Chlorine Gas (Moist)	Glycol	Nitric Acid 20%	Sodium Arsenite	
Barium Sulfate	Chlorine Water	Glycolic Acid	Nitric Acid 40%	Sodium Benzoate	
Barium Sulfide	Chlorosulfonic Acid	Green Liquor (Paper Industry)	Nitric Acid 60%	Sodium Bicarbonate	
Beet – Sugar Liquor	Chrome Alum	Heptane	Nitrobenzene	Sodium Bisulfate	
Benzene Sulfonic Acid 10%	Chromic Acid 10%	Hexanol, Tertiary	Nitrous Oxide	Sodium Bisulfite	
Benzoic Acid	Chromic Acid 30%	Hydrobromic Acid 20%	Oils and Fats	Sodium Bromide	
	Chromic Acid 40%	Hydrochloric Acid 0% – 25%	Oils – Petroleum – (See Type)	Sodium Chlorate	
	Chromic Acid 50%	Hydrochloric Acid 25% – 40%	Oleic Acid	Sodium Chloride	
	Citric Acid	Hydrocyanic Acid or Hydrogen Cyanide	Oxalic Acid	Sodium Cyanide	
	Copper Chloride		Palmitic Acid 10%		
	Copper Cyanide				

# Index

Cat. No.	Page No.	Cat. No.	Page No.	Cat. No.	Page No.
11807-350	36	12011Y-500	7	A273EF	13
11808-5200	36	1205AKR-001	7	A293DEF	12
11809-4500	36	1205AKY-001	7	A340F	28
11809-900	36	1207AAC-001	7	A343F	28
11810-250	36	1207AAR-001	7	A353F	28
11810-4500	36	1207AAY-001	7	A400	18
11810T-2300	36	1808-250C	36	A410	18
11810T-250	36	988D	66	A411	18
11811-1100	36	A122	14	A412	18
11811-250	36	A13D2S1JNNB1000	41	A413	18
11811-2500	36	A13D2S1JNNB1500	41	A414	18
11811-500	36	A13D2S1JNNB1800	41	A420	18
11811-700	36	A13D2S1JNNB2000	41	A421	18
11811T-250	36	A13D2S1JNNB250	41	A422	18
11812-250	36	A13D2S1JNNB500	41	A470D	19
11812AG-001	36	A13D2S1JNNB750	41	A471	19
11813-1200	36	A200D	9	A472	19
11813-250	36	A200E	9	A52151D	17
11813-500	36	A200F	9	A52151E	17
11813-750	36	A210D	9	A52171D	17
11815-250	36	A210E	9	A52171E	17
11815-800	36	A210F	9	A5217DE	17
12005-200	8	A220D	9	A521DE	17
12005-UPC	8	A220E	9	A5329DE	18
12005AK-001	7	A220F	9	A540DS	18
12005AKC-001	7	A220G	9	A58381D	17
12005C-370	8	A220H	9	A58381E	17
12005R-200	8	A220J	9	A5D2E1JNNA250	41
12005Y-200	8	A230D	9	A5D2E1JNNA250b	41
12007-100	8	A230E	9	A5D2S1JNNB1000	41
12007-UPC	8	A230F	9	A5D2S1JNNB1800	41
12007AA-001	7	A238	14	A5D2S1JNNB2000	41
12007C-240	8	A238DIV	14	A5D2S1JNNB250	41
12007R-100	8	A240D	15	A5D2S1JNNB250B	41
12007Y-100	8	A240E	15	A5D2S1JNNB2700	41
12008-010	8	A240F	15	A5D2S1JNNB500	41
12008-100	8	A243D	15	A5D2S1JNNB5000	41
12008-750	7	A243E	15	A5D2S1JNNB500B	41
12008C-160	8	A243F	15	A5D2S1JNNB6500	41
12008C-750	7	A245D	13	A5D2S1JNNB7000	41
12008R-100	8	A245E	13	A5D2S1JNNB8000	41
12008R-750	7	A245F	13	A615D	20
12008Y-100	8	A253D	15	A615DE	20
12008Y-750	7	A253E	15	A615DH	20
12009-750	7	A253F	15	A615DJ	20
12010-750	7	A263D	13	A615DL	20
12010Y-750	7	A263E	13	A615E	20
12011-500	7	A263F	13	A6D2E1JNNA250	41
12011R-500	7	A273DE	13	A6D2E1JNNA250B	41

## Index

Cat. No.	Page No.	Cat. No.	Page No.	Cat. No.	Page No.
A6D2S1JNNB1000	41	C980DFN-CTN	70	CG4X1C-200	23
A6D2S1JNNB1600	41	C980EFN-CTN	70	CG4X1C-3200	22
A6D2S1JNNB250	41	C980FFN-CTN	70	CG4X1C-500	22
A6D2S1JNNB2500	41	C9811DN	71	CG4X1C-6500	22
A6D2S1JNNB250B	41	C9811EN	71	CG4X1C-900	22
A6D2S1JNNB4000	41	C9811FN	71	CH4X1-150S	23
A6D2S1JNNB500	41	C9812F	72	CH4X1C	34
A6D2S1JNNB5000	41	C981DFN-CTN	70	CH4X1C-1200	22
A6D2S1JNNB500B	41	C981EFN-CTN	70	CH4X1C-150	23
A6D2S1JNNB6000	41	C981FFN-CTN	70	CH4X1C-350	22
A6D2S1JNNB7000	41	C982DFN-CTN	70	CH4X1C-4000	22
A861	16	C982EFN-CTN	70	CJ4X1-100S	23
A862D	16	C982FFN-CTN	70	CJ4X1-200S	22
A862E	16	CC120B	21/56	CJ4X1C	34
A863-4SQ	11	CD4X1C	34	CJ4X1C-100	23
A863-4SQF	11	CD4X1C-1500	22	CJ4X1C-1400	22
A863BC	10	CD4X1C-500	23	CJ4X1C-2000	22
A863CF	10	CE4X1-1000	22	CJ4X1C-225	22
A863CFF	11	CE4X1-1000S	22	CJ4X1C-2800	22
A863CFG	10	CE4X1-350	23	CJ4X1C-700	22
A863CFGF	11	CE4X1-350S	23	CL4X1C	34
A863D	11	CE4X1C	34	CL4X1C	34
A863DF	11	CE4X1C-1000	22	CL4X1C-150	22
A863DG	11	CE940DR-CTN	59	DE4X1-1000	24
A863DGF	11	CE940ER-CTN	59	DE4X1-350	25
A863MB	12	CE940F-UPC	59	DE4X1C	34
A863S	10	CE9801-CTN	71	DF4X1-250	25
A863SF	11	CE9802	72	DF4X1-250S	25
A863SG	10	CE9802D-CTN	72	DF4X1C	34
A863SGF	11	CE9802E-CTN	72	DF4X1C-1000	24
A864D	16	CE9812D-CTN	72	DF4X1C-125	25
A864E	16	CE9812E-CTN	72	DF4X1C-1500	24
A864F	16	CF4X1-100S	23	DF4X1C-250	25
A9D2S1JNNB1000	41	CF4X1-250	23	DF4X1C-2700	24
A9D2S1JNNB2200	41	CF4X1-250S	23	DF4X1C-500	25
A9D2S1JNNB250	41	CF4X1C	34	DF4X1C-500R	24
A9D2S1JNNB250B	41	CF4X1C-100	23	DF4X1C-5200	24
A9D2S1JNNB2900	41	CF4X1C-1000	22	DF4X1C-6500	24
A9D2S1JNNB4000	41	CF4X1C-1500	22	DF4X1C-7000	24
A9D2S1JNNB500	41	CF4X1C-250	23	DF4X1C-9400	24
C861G	16	CF4X1C-500	22	DG4X1-200	25
C979DFN	70	CF4X1C-5200	22	DG4X1-200S	25
C979EFN	70	CF4X1C-6500	22	DG4X1C	34
C979FFN	70	CF4X1C-8000	22	DG4X1C-1500	24
C9801-347	71	CG4X1-200S	23	DG4X1C-1600	24
C9801DN	71	CG4X1-500S	22	DG4X1C-200	25
C9801EN	71	CG4X1-900S	22	DG4X1C-3200	24
C9801FN	71	CG4X1C	34	DG4X1C-4500	24
C9802F	72	CG4X1C-1600	22	DG4X1C-500	25

## Index

Cat. No.	Page No.	Cat. No.	Page No.	Cat. No.	Page No.
DG4X1C-500R	24	E442T	60	E941L	59
DG4X1C-5600	24	E460R-CAR	19	E941N	59
DG4X1C-6500	24	E900NS8	51	E941PF	59
DG4X1C-900	24	E900NSW	51	E941RF	59
DH4X1-150S	25	E910D	43	E942D	61
DH4X1C	34	E910E	43	E942E	36/61
DH4X1C-1200	24	E910F	43	E942F	36/50/61
DH4X1C-150	25	E910G	43	E942G	36/61
DH4X1C-4000	24	E910H	43	E942H	36/50/61
DH4X1C-4500	24	E910J	43	E942J	36/50/61
DJ4X1-100S	25	E910REAMD	43	E942K	36/61
DJ4X1C	34	E910REAME	43	E942L	36/50/61
DJ4X1C-100	25	E910REAMF	43	E942M	61
DJ4X1C-2000	24	E910REAMG	43	E942N	36/50/61
DJ4X1C-2800	24	E910REAMH	43	E942NX9	61
DJ4X1C-700	24	E910REAMJ	43	E942P	50/61
DL4X1C	34	E910REAMKIT	43	E942R	50/61
DL4X1C-250	25	E920D	43	E942RX	61
DL4X1C-750	24	E920E	43	E943D	15/61
E200JS6	51	E920F	43	E943DW	64
E200KS7	51	E920G	43	E943E	15/29/36/61
E200LS7	51	E920H	43	E943EW	64
E200LSS	51	E920J	43	E943F	15/29/36/50/61
E200MS8	51	E92CSH	21/65	E943FW	64
E200NS8	51	E92CSJ	21/65	E943G	15/29/36/61
E200NSS	51	E92CSL	21/65	E943GW	64
E200PS8	51	E92CSN	21/65	E943H	15/29/36/50/61
E200PS9	51	E92CSP	21/65	E943HW	64
E200RS1	51	E92CSR	21/65	E943J	15/29/36/50/61
E252LJ	50	E935J	63	E943JW	64
E252NJS	50	E935L	63	E943K	36/61
E252NL	50	E935N	63	E943L	36/50/61
E252PN	50	E935P	63	E943M	61
E252RNS	50	E935R	63	E943N	36/50/36
E252RP	50	E940D	15/59	E943P	50/61
E297J	50	E940E	15/29/36/59	E943R	50/61
E297JN	50	E940F	15/29/36/59	E945D	58
E297L	50	E940G	15/29/36/59	E945DX	58
E297N	50	E940H	15/29/36/59	E945E	58
E297NT	50	E940J	15/29/36/59	E945EX	58
E297P	50	E940K	36/59	E945F	58
E297PS	50	E940L	36/59	E945FX	58
E297PT	50	E940M	59	E945G	58
E297RF	50	E940N	36/59	E945GX	58
E297RR	50	E940P	59	E945H	58
E299JM	50	E940R	59	E945HX	58
E299JR	50	E941H	59	E945J	58
E299NX7	50	E941J	59	E945JX	58
E442R	60	E941K	59	E945K	58

## Index

Cat. No.	Page No.	Cat. No.	Page No.	Cat. No.	Page No.
E945KX	58	E950JH-CAR	63	E977EC	74
E945KXL	59	E950KJ-CAR	63	E977FC	74
E945L	58	E950LJ-CAR	63	E977GC	74
E945LX	58	E950LK	63	E977HC	74
E945M	58	E950NL	63	E977JC	74
E945MX	58	E952JH	63	E977KC-CAR	74
E945N	58	E952KJ	63	E977LC-CAR	74
E945NX	58	E952LJ	63	E977NC-CAR	74
E945P	58	E952LK	63	E977NDC-CTN	75
E945PX	58	E952NJF	63	E977NEC-CTN	75/76
E945R	58	E952NL	63	E978DC-CAR	73
E945RX	58	E952NM	63	E978EC-CAR	73
E948H	60	E952PN	63	E978FC-CAR	73
E948J	60	E952RNF	63	E978GC-CAR	73
E948JR	60	E952RP	63	E978HC-CAR	73
E948JS	60	E954HX	60	E978JC-CAR	73
E948K	60	E954J	60	E979DFN-CAR	70
E948KS7	60	E954JX	60	E979EFN-CAR	70
E948L	60	E954JXS (Split)	76	E979FFN	70
E948L12	60	E954JXX	76	E9801	71
E948L6	60	E954K	60	E9801DN	71
E948LS	60	E954KX	60	E9801EN	71
E948N	60	E954KXX	76	E9801FN	71
E948N12	60	E954L	60	E9802	72
E948N7	60	E954LX	60	E9802CN-CAR	72
E948NS	60	E954LXS (Split)	76	E9802D	72
E948P	60	E954LXX	76	E9802E	72
E948PS	60	E955D	58	E9802F	72
E948R	60	E955E	58	E980CM-CAR	72
E948R10	60	E955F	58	E980CN-CAR	72
E948R12	60	E955G	58	E980DFN	70
E948RS	60	E955H	58	E980EFN	70
E949J5	64	E955J	58	E980FFN	70
E949J6	64	E958D	63	E980FFN-CAR	70
E949JN	64	E958E	63	E9811DN	71
E949JX	64	E958F	63	E9811EN	71
E949LR	64	E958G	63	E9811FN	71
E949N5	64	E958H	63	E9812D	72
E949NR	64	E958J	63	E9812E	72
E949R5	64	E958K	63	E9812F	72
E949RX	64	E958L	63	E981DFN	70
E950ED	63	E958N	63	E981EFN	70
E950FD-CAR	63	E958P	63	E981FFN	70
E950FE	63	E958R	63	E981FFN-CAR	70
E950GE-CAR	63	E970CD	65	E982DFN	70
E950GF	63	E970CE	65	E982EFN	70
E950HF-CAR	63	E971C	62	E982FFN	70
E950HG-CAR	63	E971D	62	E983D-CAR	67
E950JG-CAR	63	E977DC	74	E983E	67



## Index

Cat. No.	Page No.	Cat. No.	Page No.	Cat. No.	Page No.
E983F	67	E990D	64	HG4X4C-4000	26
E983G	67	E990E	64	HH4X4C-2000	26
E983H	67	E994D	64	HJ4X4C-2000	26
E983J	67	E994E	64	HL-10B	43
E9842D	62	E994F	64	HL-10R	43
E9842E	62	E995G	64	HL-10Y	43
E984D-CAR	67	E995J	64	HL-13AB	43
E984E	67	E996D	62	HL-13AR	43
E984F-CAR	67	E996E	62	HL-13AY	43
E984G-CAR	67	E996F	62	HL-16B	43
E984H	67	E996G	62	HL-16R	43
E984J	67	E996H	62	HL-16Y	43
E985D-CAR	67	E996J	62	HL-18B	43
E985E-CAR	67	E996K	62	HL-18R	43
E985F	67	E996L	62	HL-18Y	43
E985G	67	E996N	62	HL-21B	43
E985H-CAR	67	E997F	36/50/64	HL-21R	43
E985J	67	E997G	36/64	HL-21Y	43
E986D	65	E997H	36/50/64	HL-6XB	43
E986E	65	E997J	36/50/64	HL-6XR	43
E986F	65	E997K	36/64	HL-6XY	43
E986G	65	E997L	36/50/64	LT9E	32
E986H	65	E997M	64	LT9F	32
E986J	65	E997N	36/50/64	LT9LD	64
E986K	65	E997P	50/64	LT9LE	64
E986L	65	E997R	50/64	LT9LF	64
E986M	65	E997T	64	P258H	36/62
E986N	65	E998D	63	P258JT	36/62
E987D	66	E998E	63	P258K	36/62
E987E-CAR	66	E998E-CAR	63	P258LT	36/62
E987F-CAR	66	E998F	63	P258NT	36/62
E987G	66	E998F-CAR	63	P258PT	62
E987H	66	E998G-CAR	63	P258RT	62
E987J	66	E998H-CAR	63	S258RH	78
E987N	68	E998J-CAR	63	S28612	78/82
E987R-CAR	68	E998K-UPC	63	S287F	78/82
E988E	66	E998L	63	S287J	78/82
E988F	66	E998N	63	S288JHN	78
E988G	66	EP12128	69	S288JJN	78
E988H	66	EP181812	69	S288JLN	78
E988J	66	EP201808	69	S288LHN	78
E989N-CAR	68	EP202008	69	S288LJN	78
E989NNJ	68	EP241808	69	S288LLN	78
E989NNR	68	EP242008	69	S288NFN	78
E989PPJ	68	EP242408	69	S288NHN	78
E989R-UPC	68	EP302408	69	S288NJN	78
E989RRR-UP	68	EP362408	69	S288NLN	78
E989SSX-UPC	68	ESMFK-1	69	S288PHN	78
E989UUN	68	HF4X4C-5000	26	S288PJN	78

## Index

Cat. No.	Page No.	Cat. No.	Page No.	Cat. No.	Page No.
S288PLN	78	SCH4X1C-50	31	UA3FPB	47
S288RHN	78	SCJ4X1C-100	31	UA3FR	47
S288RJN	78	SCJ4X1C-500	31	UA3FRB	47
S288RLN	78	SNM12-100CP	4	UA3HL	47
S288SHN	78	SNM12-6R	4	UA3HN	47
S288SJN	78	SNM34-100CP	4	UA3HNB	47
S289JHN	78	SNM34-6R	4	UA3HP	47
S289JJN	78	SP2W20-1	82	UA3HR	47
S289JLN	78	SP2W20-2	82	UA3IJS	51
S289LHN	78	SP2W20-3	82	UA3INSD	51
S289LJN	78	SP2W30-1	82	UA3SNB	47
S289LLN	78	SP2W30-2	82	UA5AD	45
S289NFN	78	SP2W30-3	82	UA5AE	45
S289NHN	78	SP3W20-2	82	UA5AF	45
S289NJN	78	SP3W20-2	82	UA5AG	45
S289NLN	78	SP3W30-2	82	UA5AH	45
S289PHN	78	SP4W15-1	82	UA5AJ	45
S289PJN	78	SP4W15-2	82	UA5AK	45
S289PLN	78	SP4W15-3	82	UA5AL	45
S289RHN	78	SP4W20-1	82	UA5AM	45
S289RJN	78	SP4W20-2	82	UA5AN	45
S289RLN	78	SP4W20-3	82	UA5AP	45
S289SHN	78	SP4W30-1	82	UA5AR	45
S289SJN	78	SP4W30-2	82	UA5CJ	47
SB14105	57	SP4W30-3	82	UA5CK	47
SC100A	30	SP5W20-2	82	UA5CLB	47
SC100ADJC	30	SP5W30-2	82	UA5DJ	47
SC100SC	30	SP6W20-2	82	UA5DJB	47
SC200A	30	SP6W30-2	82	UA5DL	47
SC200ADJC	30	SRC-075	6	UA5DLB	47
SC200DV	30	SRTC-050	6	UA5DM	47
SC300A	30	SRTC-075	6	UA5DN	47
SCA240E	28/32	TL14203	57	UA5DNB	47
SCA240F	28/32	TL14505	21/57	UA5DPB	47
SCA243E	28/32	TL14510	21/57	UA5EJ	47
SCA243F	28/32	TL38203	21/57	UA5EK	47
SCA253E	28/32	TL38210	21/57	UA5EN	47
SCA253F	28/32	TL38265	21/57	UA5EPB	47
SCE4X1-100	31	UA3DJ	47	UA5FF	47
SCE4X1-1000	31	UA3DJB	47	UA5FH	47
SCE940G	29/32	UA3DN	47	UA5FJ	47
SCE940H	29/32	UA3DNB	47	UA5FJB	47
SCE940J	29/32	UA3FJ	47	UA5FK	47
SCE943G	29/32	UA3FJB	47	UA5FL	47
SCE943H	29/32	UA3FL	47	UA5FLB	47
SCE943J	29/32	UA3FLB	47	UA5FN	47
SCF4X1C-100	31	UA3FN	47	UA5FNB	47
SCF4X1C-1500	31	UA3FNB	47	UA5FP	47
SCG4X1C-100	31	UA3FP	47	UA5FPB	47

---

## Index

<b>Cat. No.</b>	<b>Page No.</b>	<b>Cat. No.</b>	<b>Page No.</b>	<b>Cat. No.</b>	<b>Page No.</b>
UA5FR	47	UA6HL	47	UA7FH	46
UA5FRB	47	UA6HN	47	UA7FHB	46
UA5HL	47	UA6HNB	47	UA7FJ	46
UA5HN	47	UA6HP	47	UA7FJB	46
UA5HNB	47	UA6HPB	47	UA7FJSD	51
UA5HP	47	UA6HR	47	UA7FK	46
UA5HPB	47	UA6HRB	47	UA7FKB	46
UA5HR	47	UA7AD	45	UA7FL	46
UA5HRB	47	UA7AE	45	UA7FLB	46
UA5HT	47	UA7AF	45	UA7FLSD	51
UA5IN	47	UA7AF-CAR	45	UA7FN	46
UA5INSD	51	UA7AG	45	UA7FNB	46
UA5IP	47	UA7AH	45	UA7FP	46
UA5IR	47	UA7AJ	45	UA7FPB	46
UA5SNB	47	UA7AJ-CAR	45	UA7FR	46
UA5UPB	47	UA7AK	45	UA7FRB	46
UA6AD	45	UA7AL	45	UA7FT	46
UA6AE	45	UA7AM	45	UA7HG	46
UA6AF	45	UA7AN	45	UA7HH	46
UA6AG	45	UA7AP	45	UA7HJ	46
UA6AH	45	UA7AR	45	UA7HJB	46
UA6AJ	45	UA7BJB	46	UA7HK	46
UA6AK	45	UA7CF	46	UA7HL	46
UA6AL	45	UA7CG	46	UA7HLB	46
UA6AM	45	UA7CH	46	UA7HLSLSD	51
UA6AN	45	UA7CJ	46	UA7HN	46
UA6AP	45	UA7CJB	46	UA7HNB	46
UA6AR	45	UA7CK	46	UA7HP	46
UA6CJ	47	UA7CL	46	UA7HPB	46
UA6CL	47	UA7CLB	46	UA7HR	46
UA6DJ	47	UA7DF	46	UA7HRB	46
UA6DJB	47	UA7DG	46	UA7HT	46
UA6DK	47	UA7DH	46	UA7IJSJSD	51
UA6DL	47	UA7DJ	46	UA7ILSD	51
UA6DLB	47	UA7DJB	46	UA7INSD	51
UA6DN	47	UA7DJSD	51	UA7IPB	46
UA6FJ	47	UA7DK	46	UA7NNB	46
UA6FJB	47	UA7DKB	46	UA7NPB	46
UA6FL	47	UA7DL	46	UA7SPB	46
UA6FLB	47	UA7DLB	46	UA9AD	45
UA6FM	47	UA7DM	46	UA9ADR-CAR	45
UA6FN	47	UA7DN	46	UA9AE	45
UA6FNB	47	UA7DNB	46	UA9AFR-CTN	45
UA6FP	47	UA7EN	46	UA9AG	45
UA6FPB	47	UA7ENB	46	UA9AH	45
UA6FR	47	UA7EP	46	UA9AJ	45
UA6FRB	47	UA7EPB	46	UA9AK-CAR	45
UA6HJ	47	UA7FF	46	UA9AL	45
UA6HJB	47	UA7FG	46	UA9AM	45

## Index

Cat. No.	Page No.	Cat. No.	Page No.	Cat. No.	Page No.
UA9AN	45	UA9FHB		UB5FJB	49
UA9AP	45	UA9FJ-UPC	46	UB5FLB	49
UA9AR	45	UA9FJB	46	UB5FNB	49
UA9CF	46	UA9FK-UPC	46	UB5FP	49
UA9CFB	46	UA9FKB	46	UB6AD	48
UA9CG	46	UA9FL	46	UB6AE	48
UA9CGB	46	UA9FLB	46	UB6AF	48
UA9CH	46	UA9FM	46	UB6AG	48
UA9CHB	46	UA9FMB	46	UB6AH	48
UA9CJ	46	UA9FN	46	UB6AJ	48
UA9CJB	46	UA9FNB	46	UB6AK	48
UA9CK	46	UA9FP	46	UB6AL	48
UA9CKB	46	UA9FPB	46	UB6AN	48
UA9CL	46	UA9FR	46	UB6AP	48
UA9CLB	46	UA9FRB	46	UB6AR	48
UA9CNB	46	UA9HF	46	UB6FN	49
UA9DF	46	UA9HG	46	UB7AD	48
UA9DFB	46	UA9HH	46	UB7AE-UPC	48
UA9DG	46	UA9HJ	46	UB7AF-UPC	48
UA9DGB	46	UA9HJB	46	UB7AG	48
UA9DH	46	UA9HK	46	UB7AH	48
UA9DHB	46	UA9HKB	46	UB7AH-CAR	48
UA9DJ	46	UA9HL	46	UB7AJ-UPC	48
UA9DJB-UPC	46	UA9HLB	46	UB7AK	48
UA9DK	46	UA9HM	46	UB7AL	48
UA9DKB-UPC	46	UA9HMB	46	UB7AN	48
UA9DL	46	UA9HN	46	UB7AP	48
UA9DLB-UPC	46	UA9HNB	46	UB7AR	48
UA9DM	46	UA9HP	46	UB7CF	49
UA9DMB	46	UA9HPB	46	UB7CJ	49
UA9DN	46	UA9HR	46	UB7CL	49
UA9DNB	46	UA9HRB	46	UB7DF	49
UA9EF	46	UA9HT*	46	UB7DH	49
UA9EFB	46	UA9IL	46	UB7DHB	49
UA9EH	46	UA9IN	46	UB7DJ	49
UA9EJ	46	UA9INB	46	UB7DJB	49
UA9EJB	46	UA9IP	46	UB7DL	49
UA9EK	46	UA9IPB	46	UB7DLB	49
UA9EKB	46	UA9IR	46	UB7DN	49
UA9EL	46	UA9IRB	46	UB7DNB	49
UA9ELB	46	UA9JJ	46	UB7FF	49
UA9EN	46	UA9JN	46	UB7FG	49
UA9ENB	46	UB3AL	48	UB7FH	49
UA9EP	46	UB3FP	49	UB7FJ	49
UA9EPB	46	UB5AL	48	UB7FJB	49
UA9FF	46	UB5AN	48	UB7FK	49
UA9FG	46	UB5AP	48	UB7FL	49
UA9FGB	46	UB5DJB	49	UB7FLB	49
UA9FH	46	UB5DL	49	UB7FN	49

---

## Index

Cat. No.	Page No.	Cat. No.	Page No.
UB7FNB	49	UB9FP	48
UB7FP	49	UB9FR	48
UB7FR	49	UB9HH	48
UB7HJ	49	UB9HJ	48
UB7HK	49	UB9HK	48
UB7HN	49	UB9HL	48
UB7HR	49	UB9HN	48
UB7IR	49	UB9HNB	48
UB9AD	48	UB9HP	48
UB9AE	48	UB9HR	48
UB9AF	48	UB9IP	48
UB9AG	48	UB9IR	48
UB9AH	48	UB9NN	48
UB9AJ	48	VC9902	53
UB9AK	48	VC9903	53
UB9AL	48	VC9922	52
UB9AN	48	VC9923	52
UB9AP	48	VC9924-24	52
UB9APB	48	VC9932	53
UB9AR	48	VC9941P	52
UB9CF	48	E942J	78
UB9CG	48	VC9961P	52
UB9CH	48	VC9962	52
UB9CJ	48	VC9963	52
UB9CK	48	VC9963SC	27/54
UB9CL	48	VC9964	52
UB9DF	48	VC9981P	53
UB9DG	48	VC9982	53
UB9DH-UPC	48	VC9983	53
UB9DHB	48	VC9984	53
UB9DJ-UPC	48	VC9992	21/54
UB9DJB	48	VC9LV2	52
UB9DK-UPC	48	VC9LV4-24	51
UB9DKB	48	VVC9LV3	51
UB9DL	48	XD10NM	5
UB9DLB	48	XD1NM	5
UB9DN	48	XD2NM	5
UB9DNB	48	XD3NM	5
UB9FF	48	XD5NM	5
UB9FG	48	XD6NM	5
UB9FH	48	XD7NM	5
UB9FJ	48	XD8NM	5
UB9FJB	48		
UB9FK	48		
UB9FKB	48		
UB9FL	48		
UB9FLB	48		
UB9FN	48		
UB9FNB	48		

**Additional information**

We reserve the right to make technical changes or modify the contents of this document without prior notice. With regard to purchase orders, the agreed particulars shall prevail. ABB AG does not accept any responsibility whatsoever for potential errors or possible lack of information in this document.

We reserve all rights in this document and in the subject matter and illustrations contained therein. Any reproduction, disclosure to third parties or utilisation of its contents – in whole or in parts – is forbidden without prior written consent of ABB AG.







—  
**US**

ABB Installation Products  
Electrification business  
860 Ridge Lake Blvd.  
Memphis, TN 38120  
+1 901-252-5000

**[www.tnb.abb.com](http://www.tnb.abb.com)**