

SOPORTE TIPO P3264 - VISTA DE PLANTA

ESC: S/E

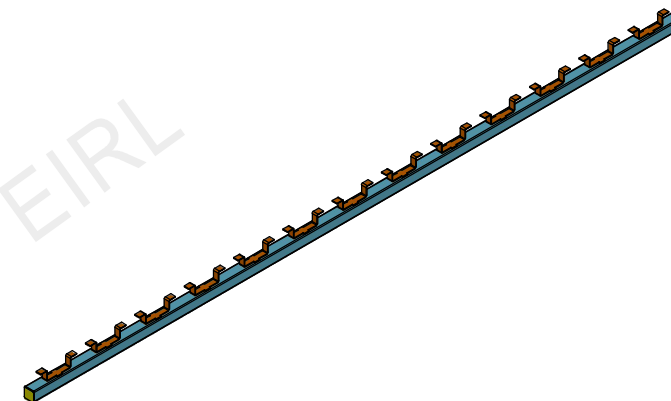

SOPORTE TIPO P3264 - VISTA ISOMETRICA

ESC: S/E

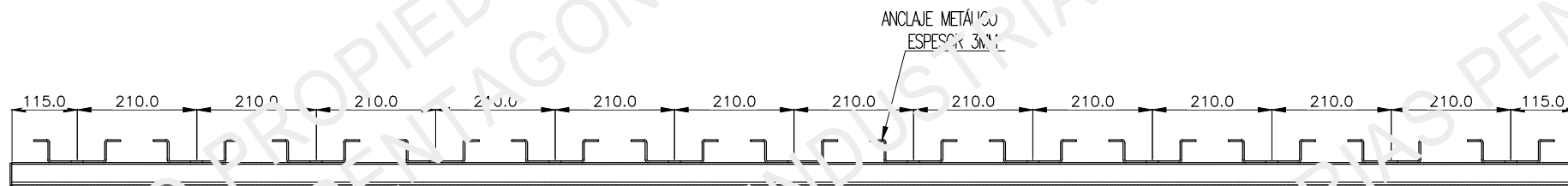

SOPORTE TIPO P3264 - VISTA LATERAL

ESC: S/E

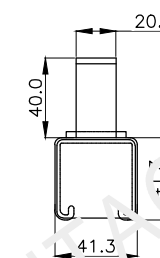

SOPORTE TIPO P3264 - VISTA TRANSVERSAL

ESC: S/F

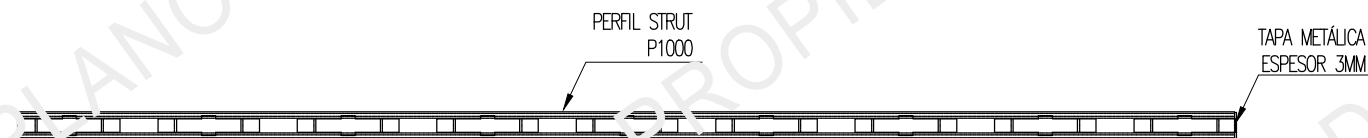

SOPORTE TIPO P3261 - VISTA DE PLANTA

ESC: S/E

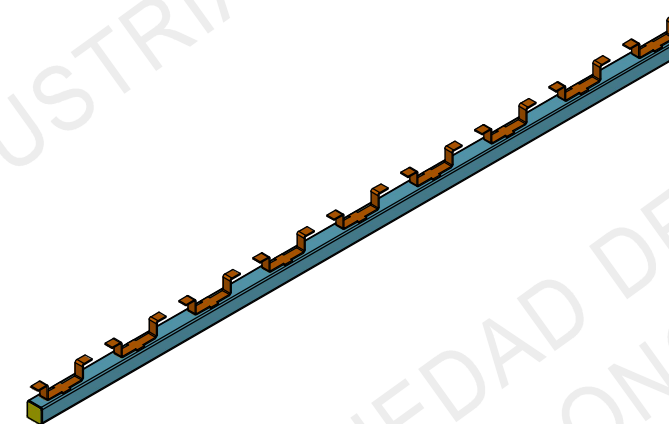

SOPORTE TIPO P3261 - VISTA ISOMETRICA

ESC: S/E

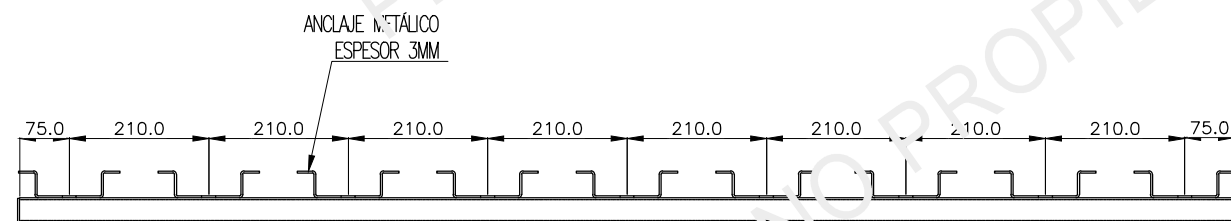

SOPORTE TIPO P3261 - VISTA LATERAL

ESC: S/E

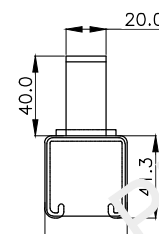

SOPORTE TIPO P3261 - VISTA TRANSVERSAL

ESC: S/E

PROPIETARIO:	CONTENIDO:
INDUSTRIAS PENTAGONO	SOPORTE EMPOTRADO SIMILAR A P3261 Y P3264
PROYECTO:	SERIE: REVISIÓN:
-	ELECTRICIDAD A
PLANO N°:	DIBUJADO POR:
ELECT-P-F008-21	CARLOS ABREU
PLANO DE REFERENCIA:	REVISIÓN:
.	.
.	.
.	.
DISEÑADO POR:	APROBADO POR:
CARLOS ABREU	JUAN QUIROZ



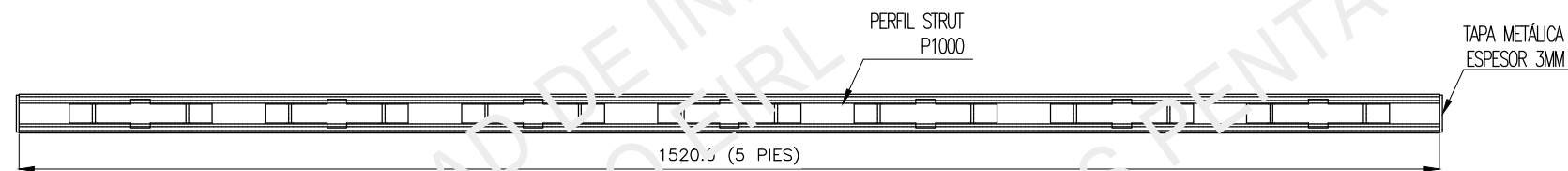

SOPORTE TIPO P3260 - VISTA DE PLANTA
ESC: S/E

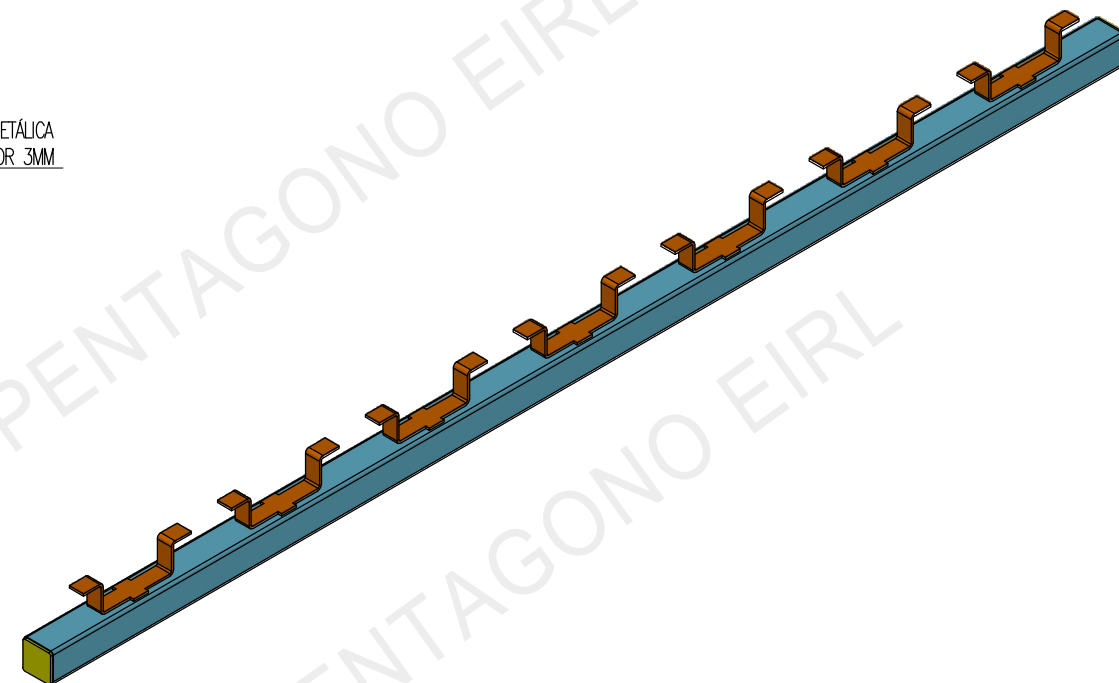

SOPORTE TIPO P3260 - VISTA ISOMETRICA
ESC: S/E

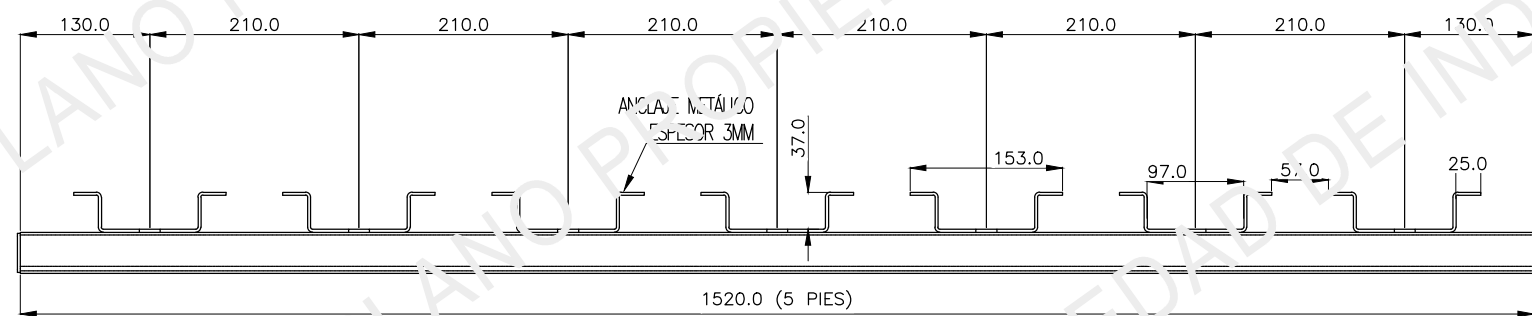

SOPORTE TIPO P3260 - VISTA LATERAL
ESC: S/E

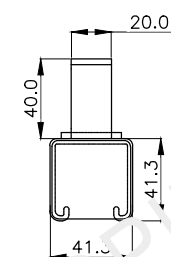

SOPORTE TIPO P3260 - VISTA TRANSVERSAL
ESC: S/E

PROPIETARIO:	CONTENIDO:
INDUSTRIAS PENTAGONO	SOPORTE EMPOTRADO SIMILAR A P3260
PROYECTO:	SERIE: REVISIÓN:
-	ELECTRICIDAD A
PLANO N°:	DIBUJADO POR:
ELECT-P-F012-21-1	CARLOS ABREU
PLANO DE REFERENCIA:	REVISIÓN:
.	.
.	.
.	.
DISEÑADO POR:	APROBADO POR:
CARLOS ABREU	JUAN QUIROZ

